

[Demaine, Demaine,  
Lubiw, O'Rourke 2002]

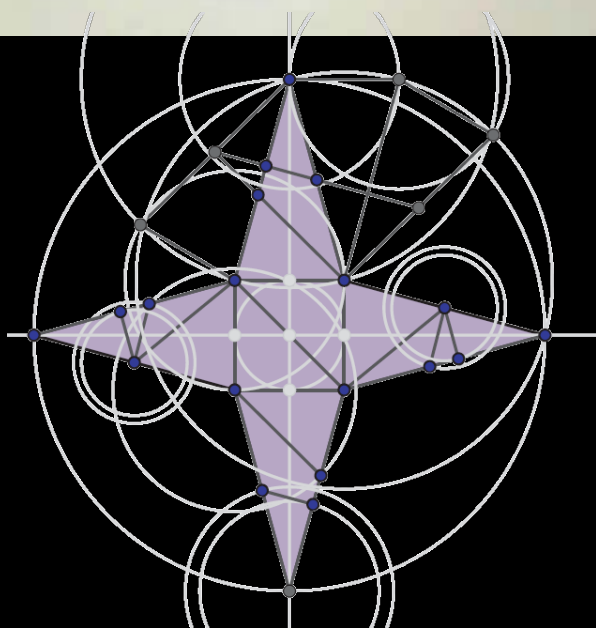

[Demaine,  
Demaine,  
Lubiw,  
O'Rourke  
2002]

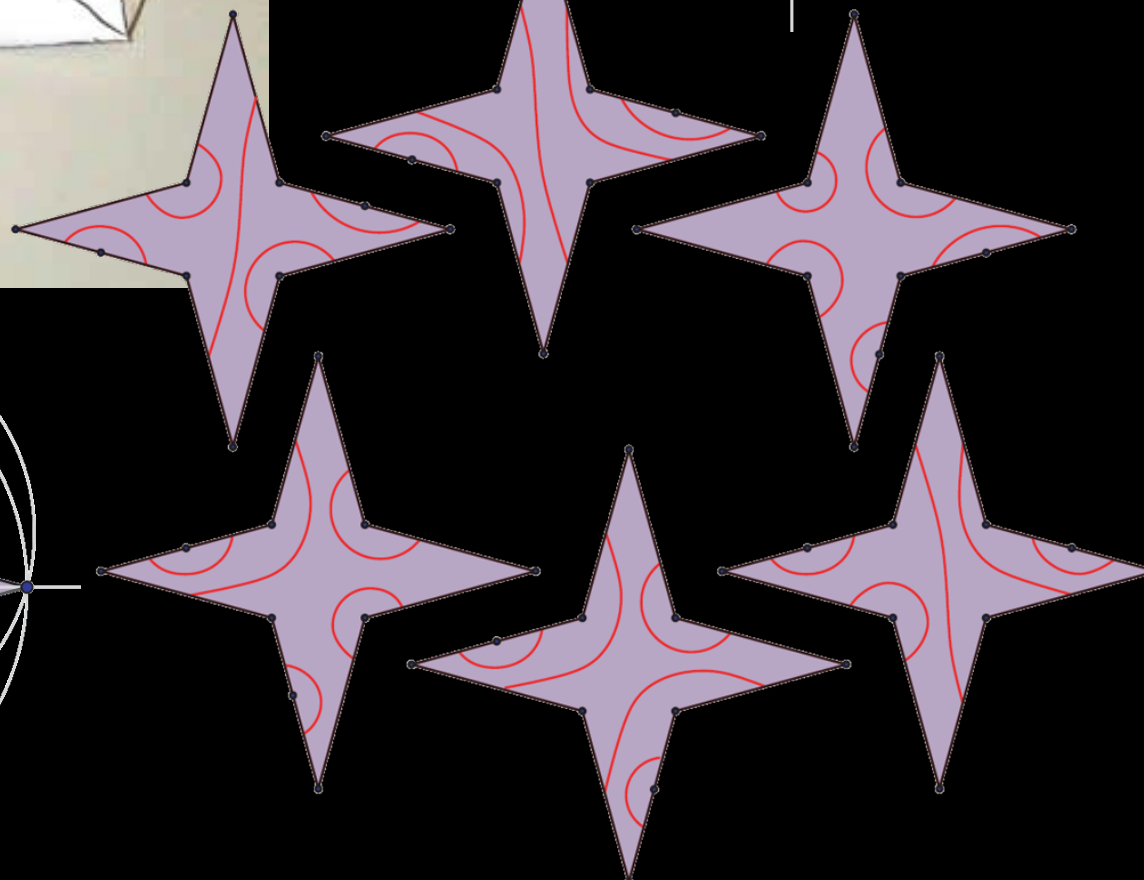
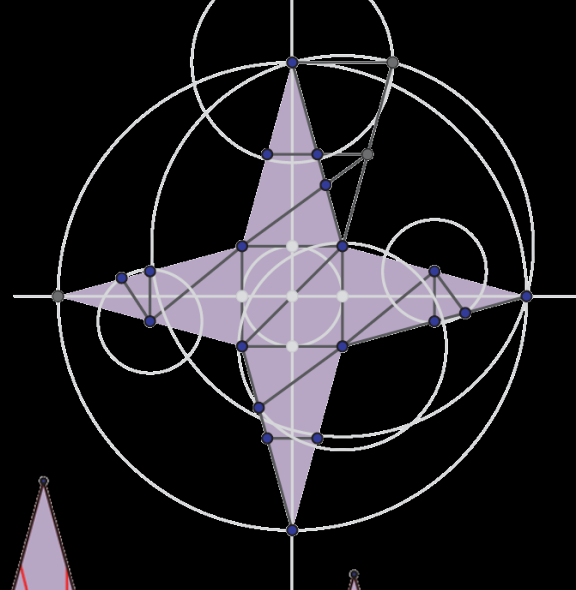
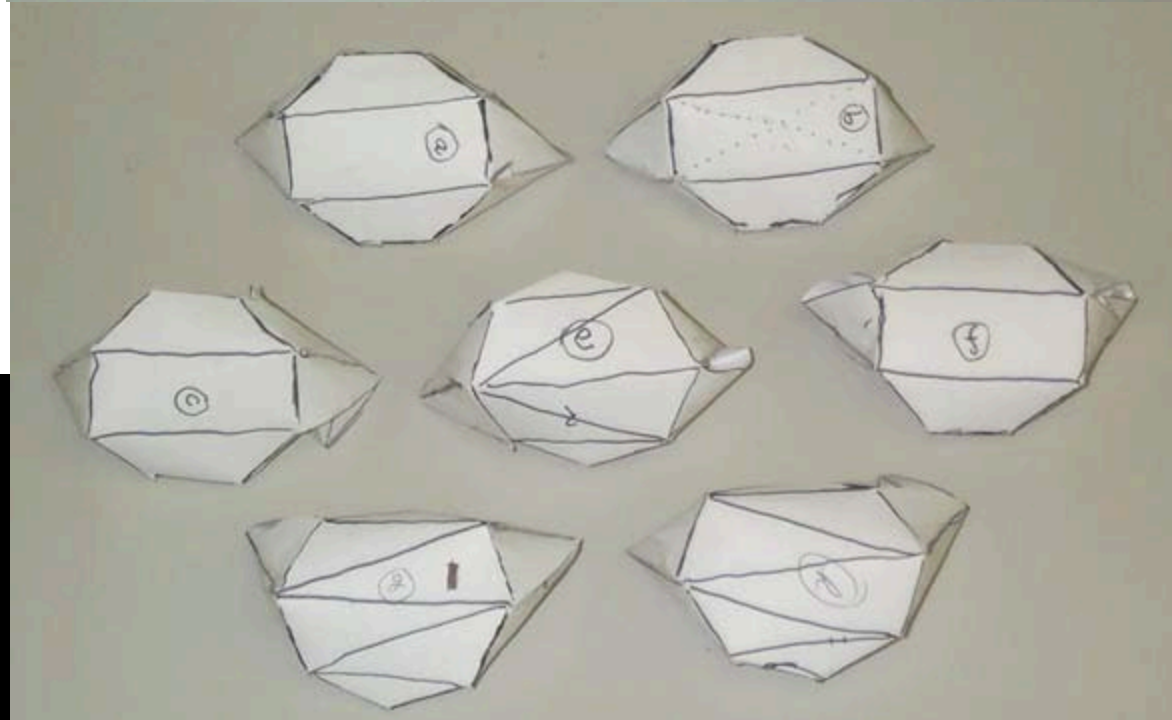
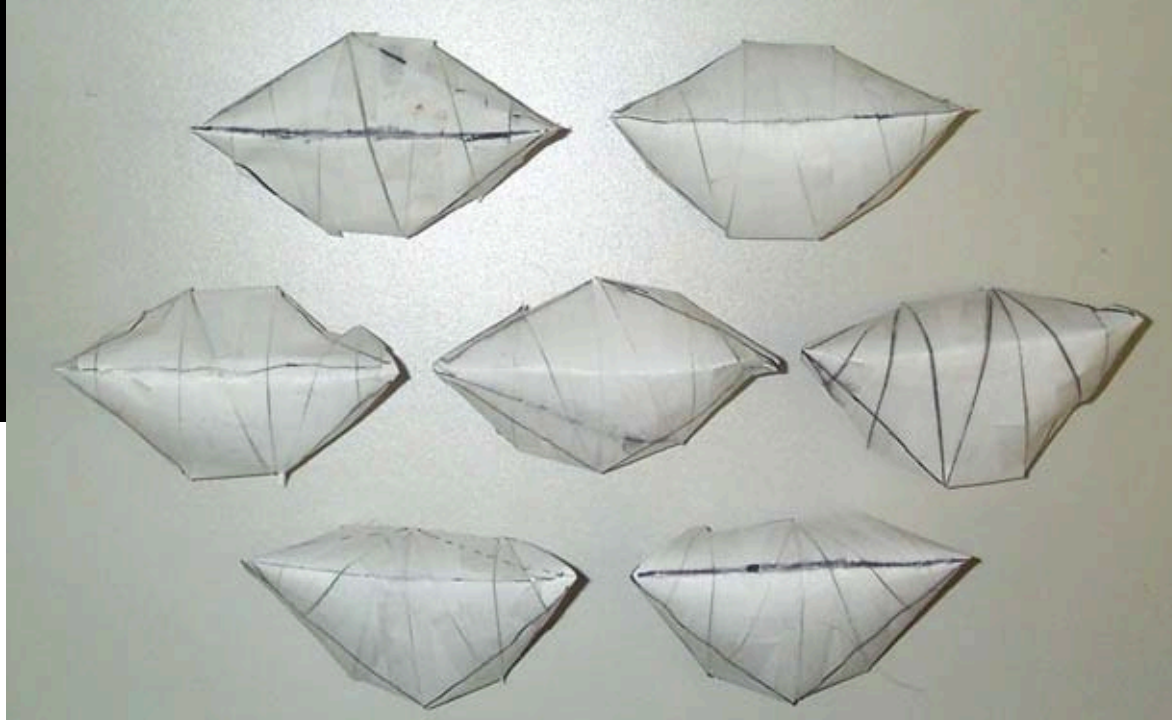
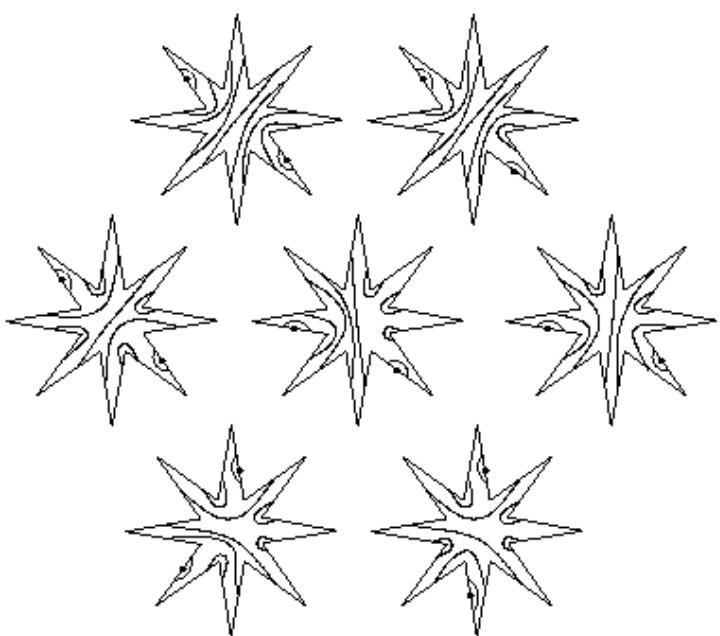

[Demaine, Demaine,  
Lubiw, O'Rourke 2002]

# Metamorphosis of the Cube

Demaine, Demaine, Lubiw, O'Rourke, Pashchenko 1999

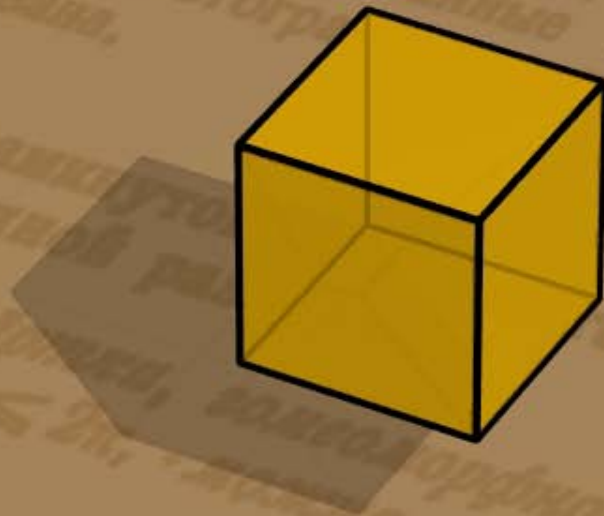



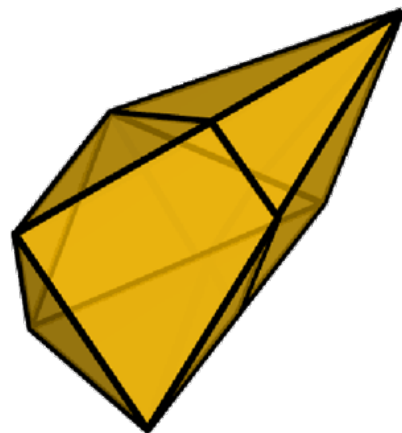
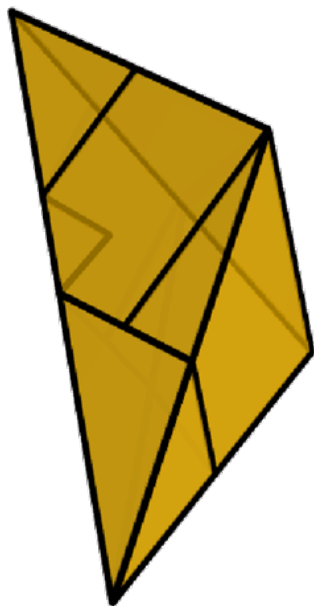
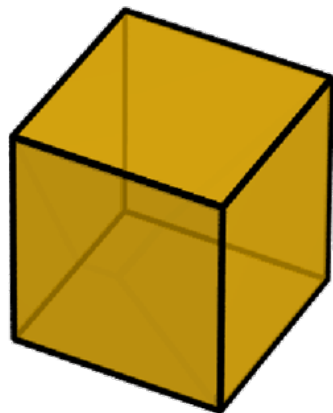
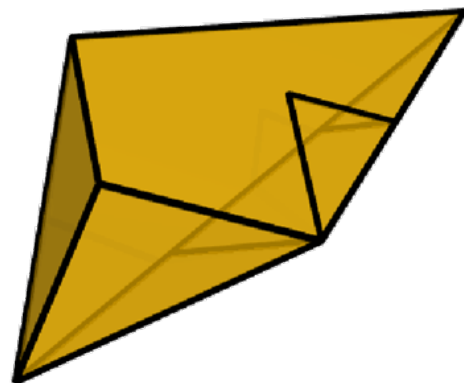
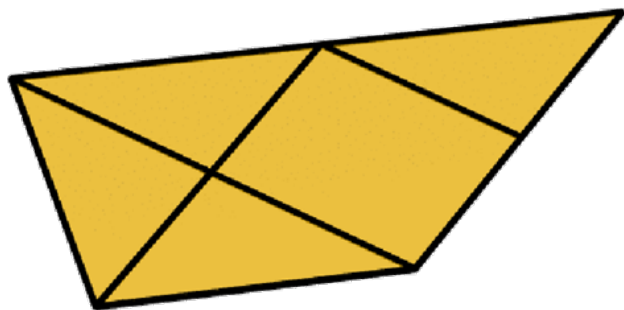



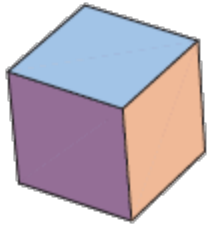
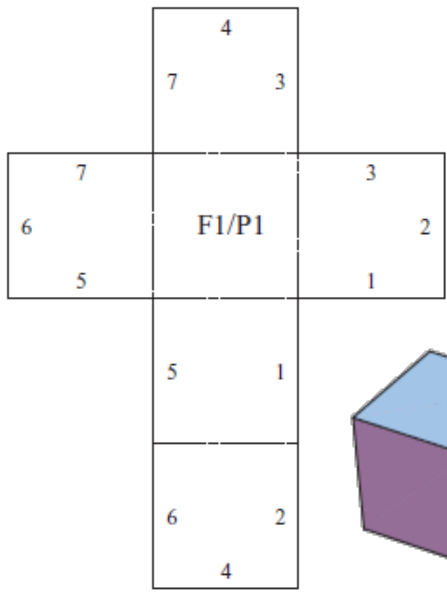

1

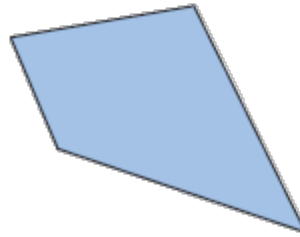
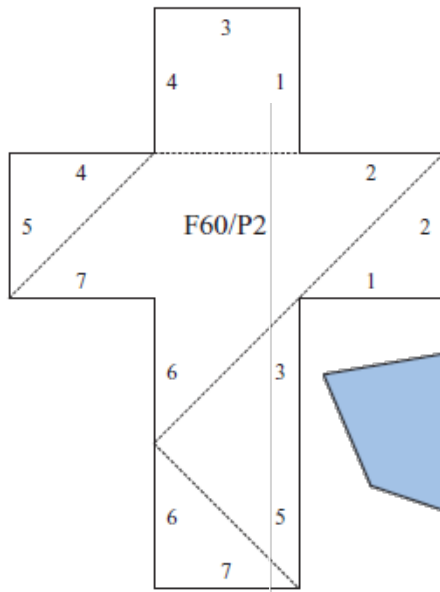

2

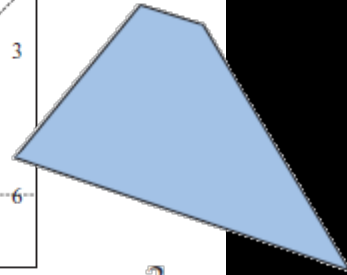
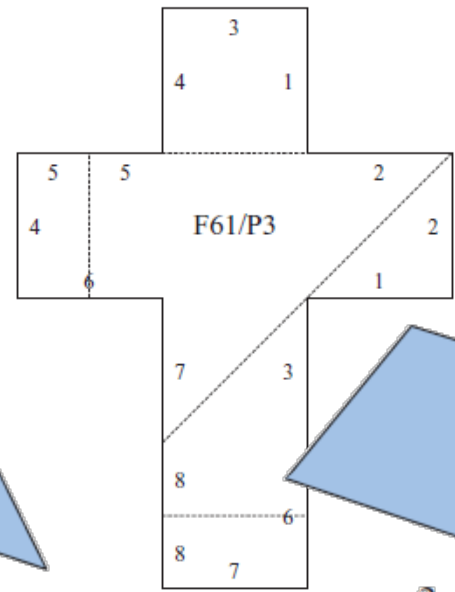

3

1x1

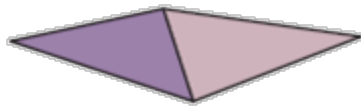
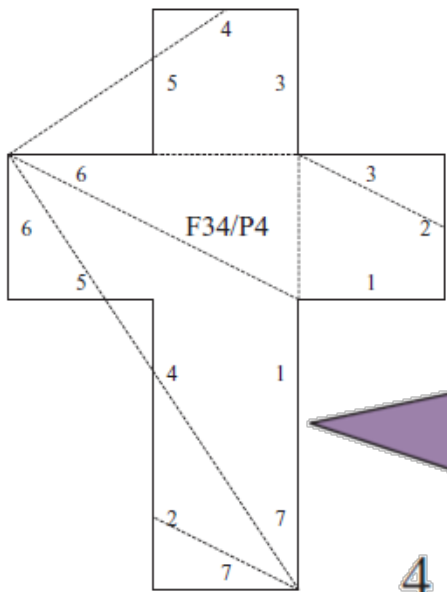

4

tetrahedron

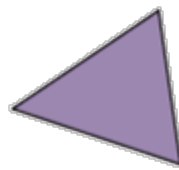
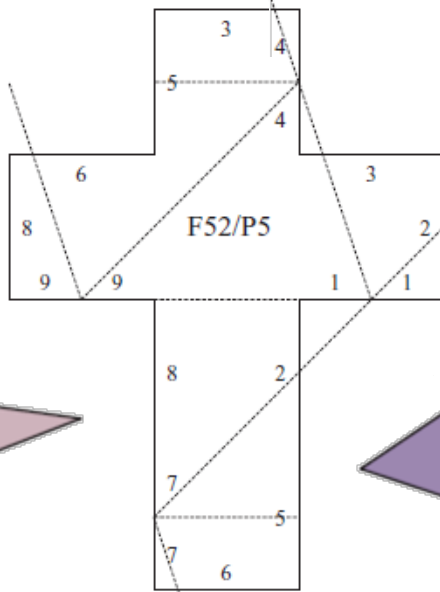

5

tetrahedron

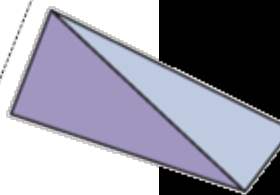
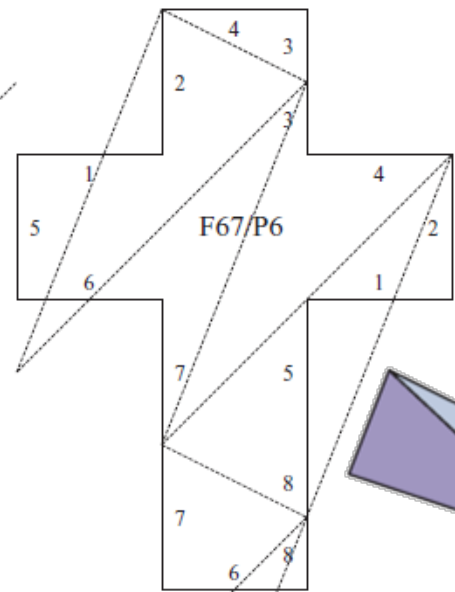

6

tetrahedron

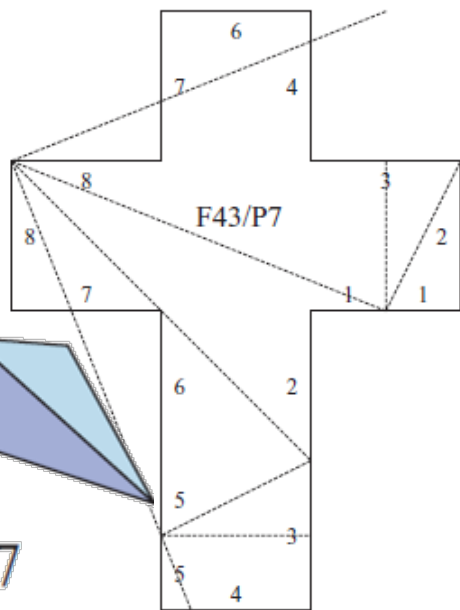

7

tetrahedron

1x1

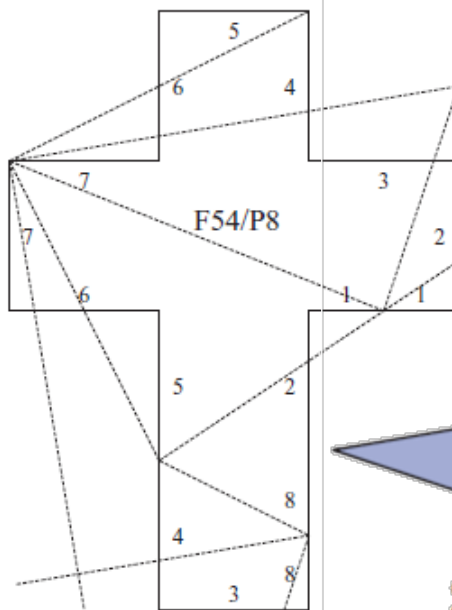

8

tetrahedron

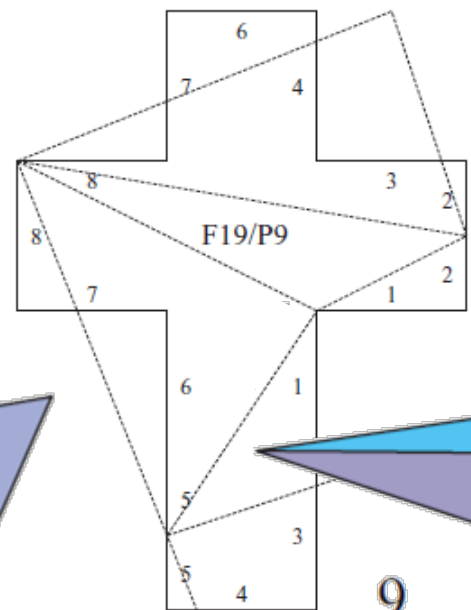

9

tetrahedron

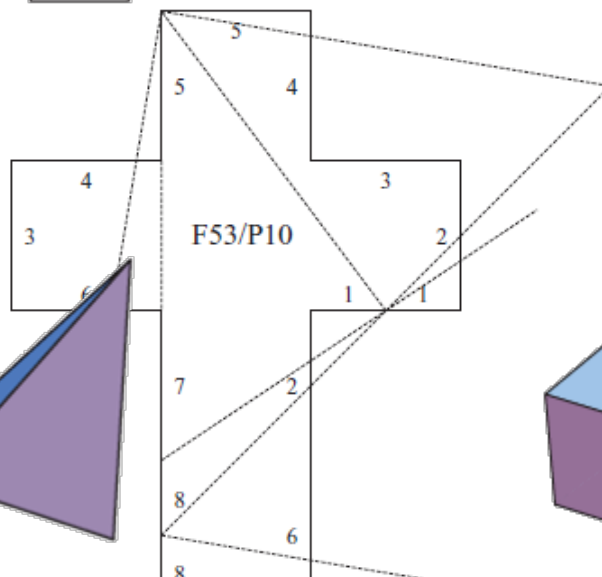

10

tetrahedron

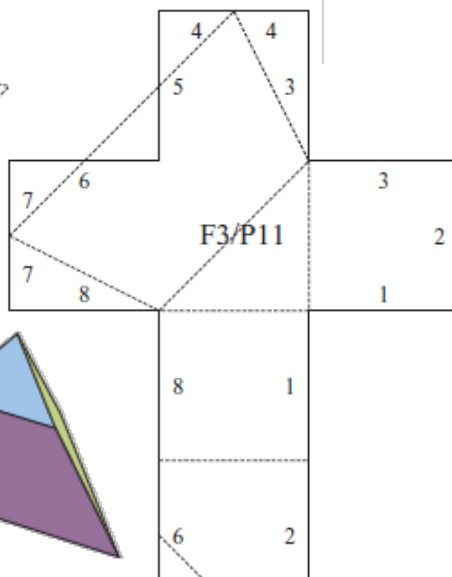

11

pentahedron

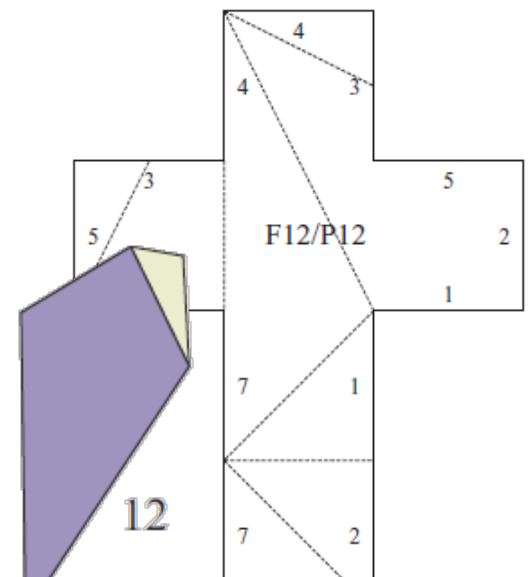

12

pentahedron



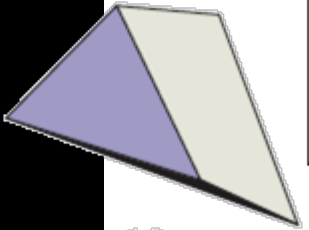
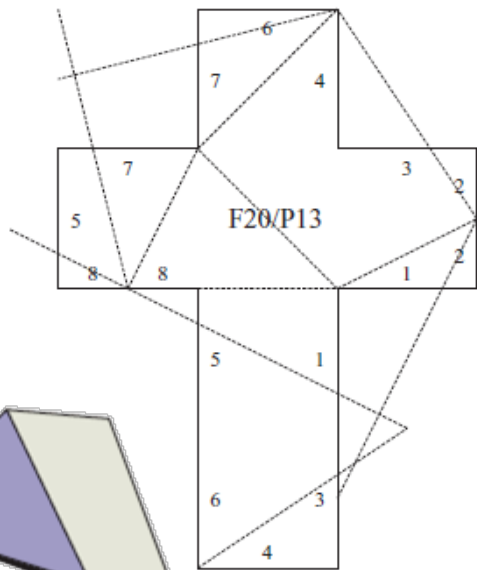

13

pentahedron

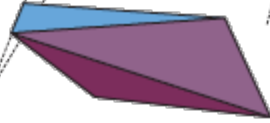
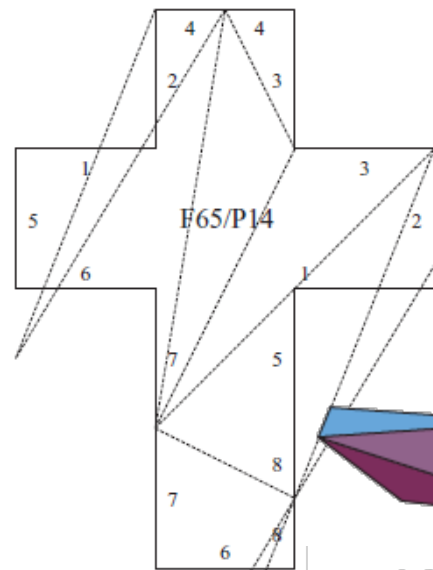

14

hexahedron

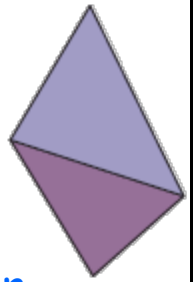
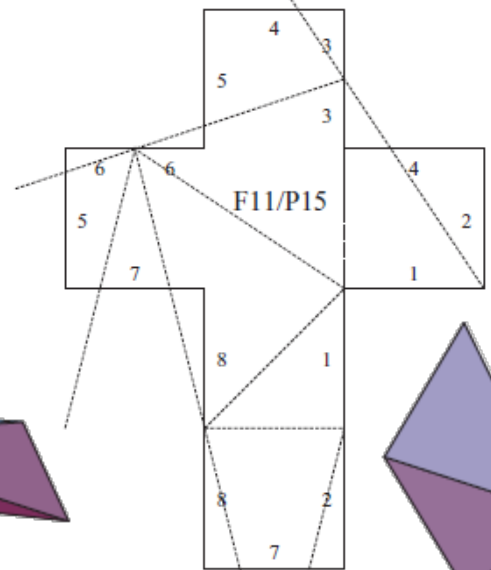

15

hexahedron

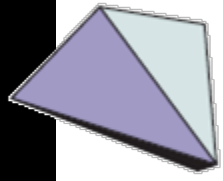
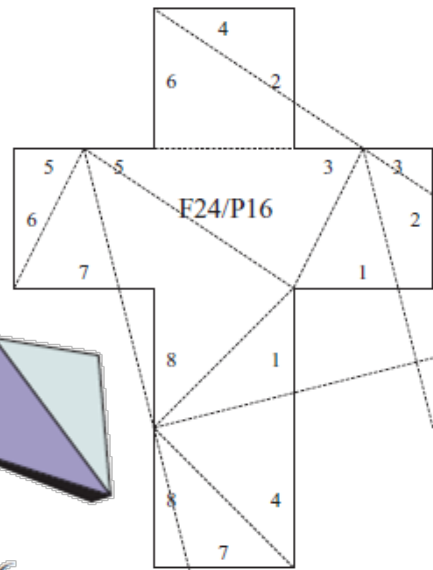

16

hexahedron

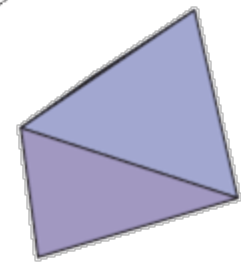
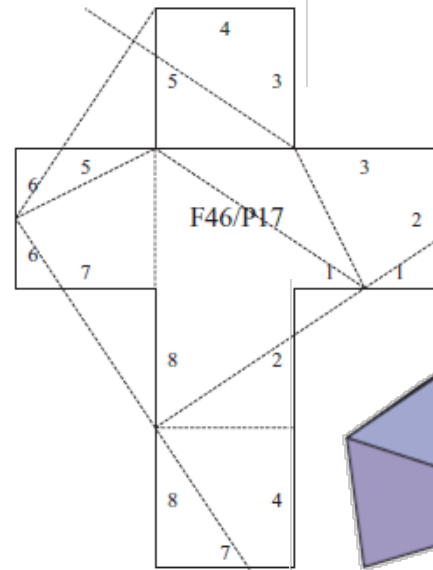

17

hexahedron

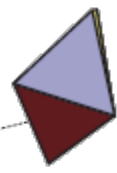
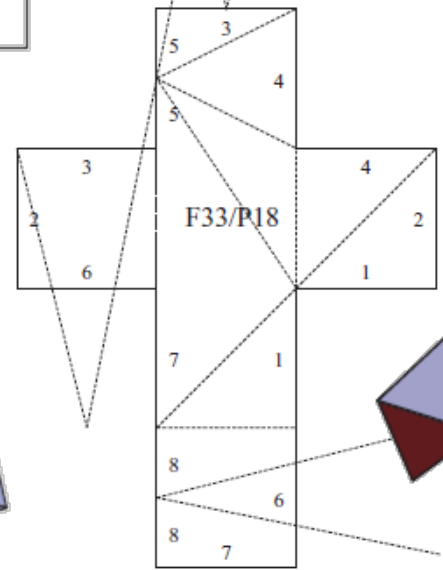

18

octahedron

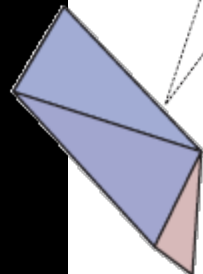
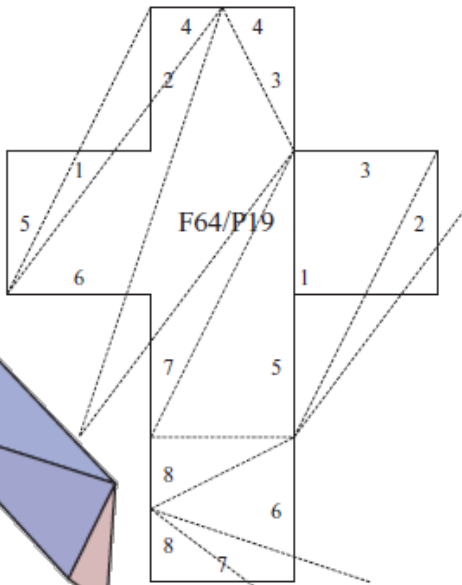

19

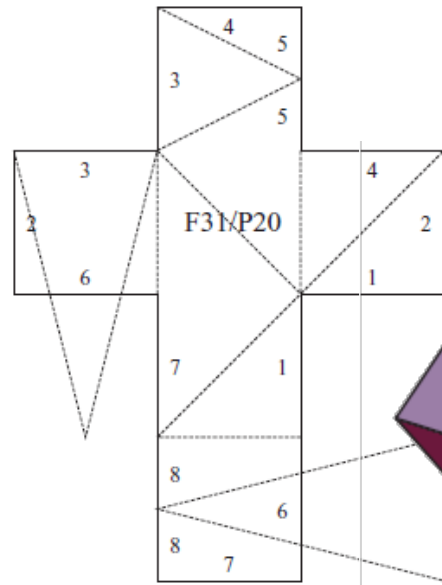

20

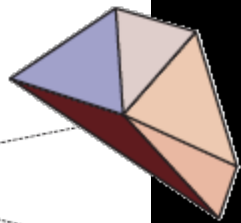
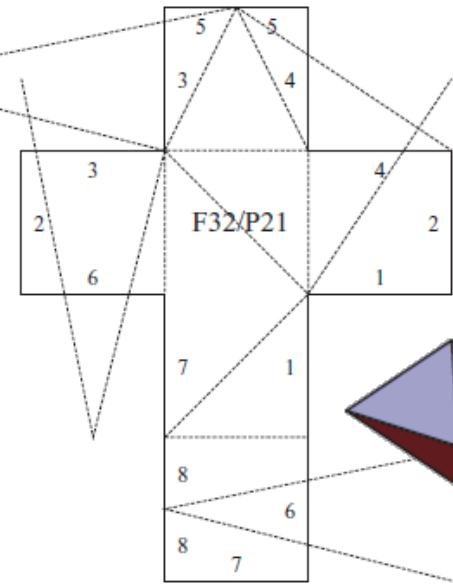

21

1x1

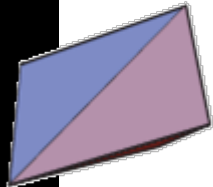
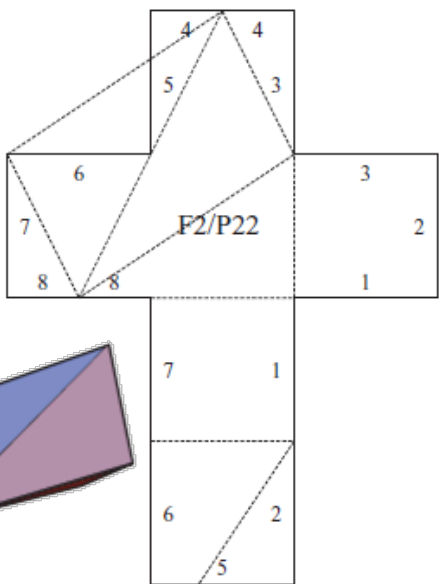

22

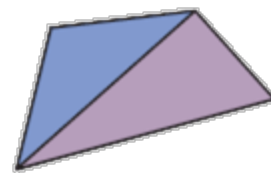
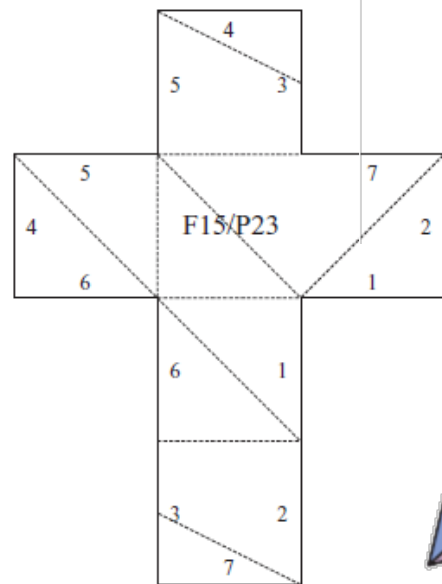

23

octahedra

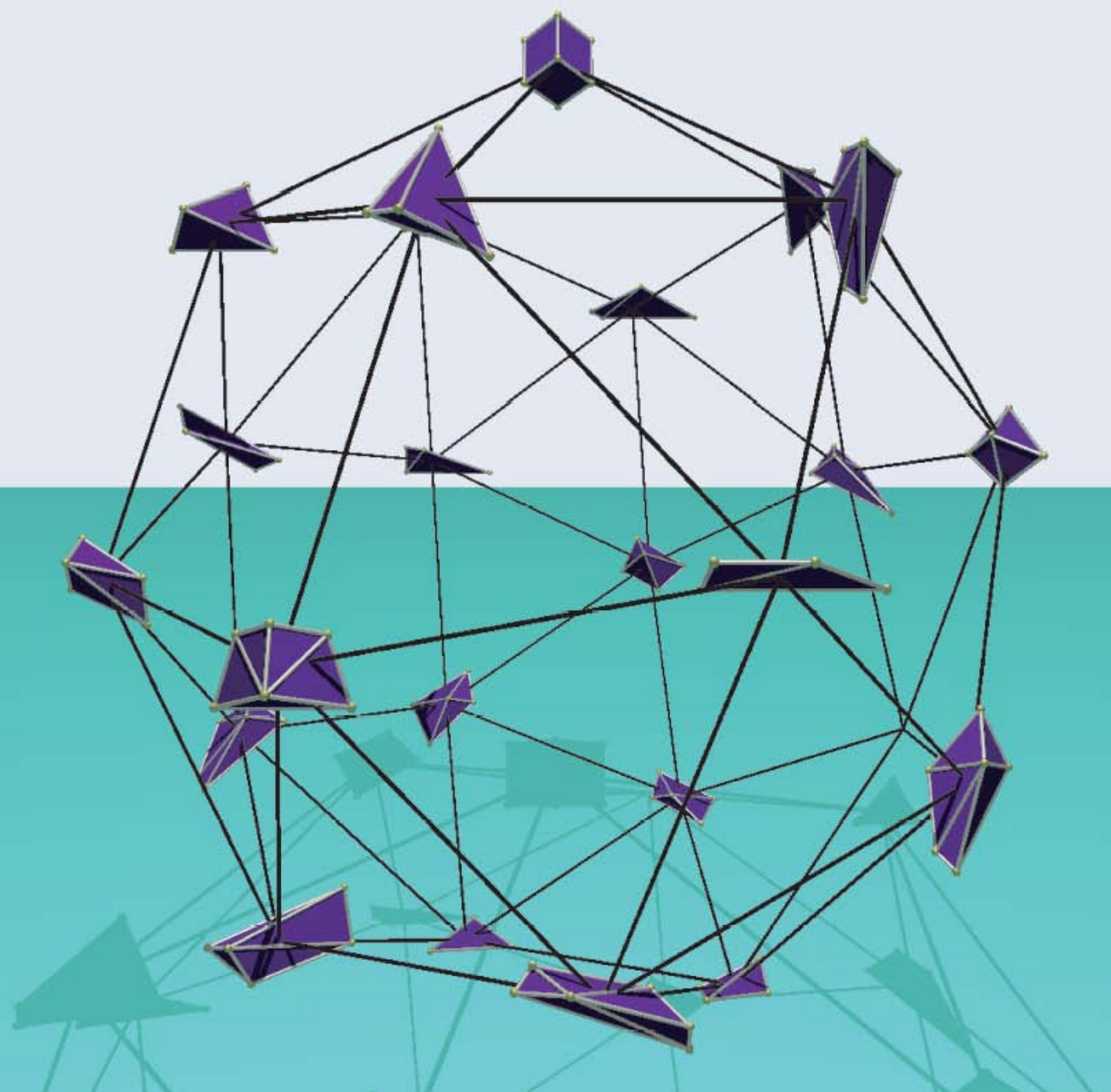

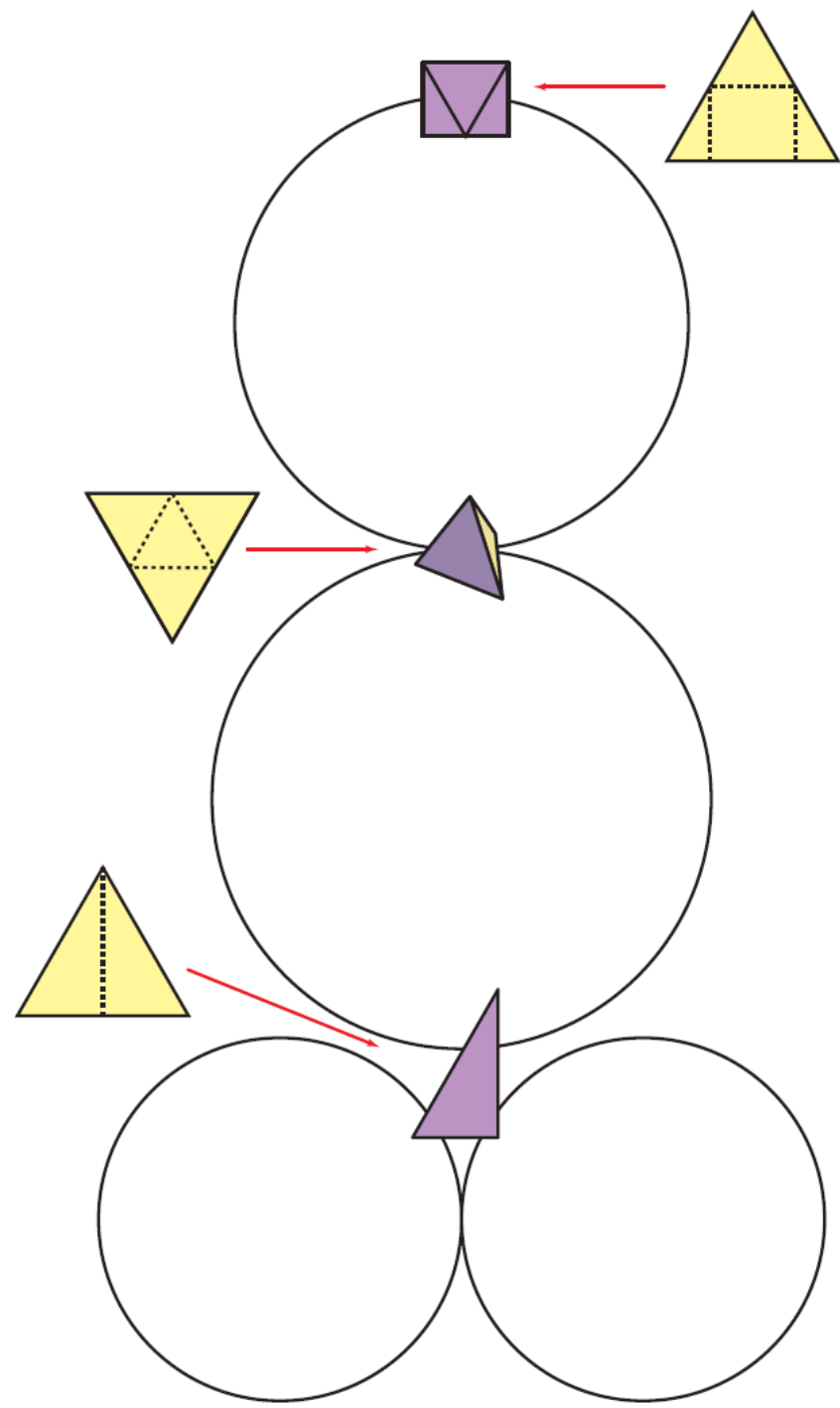

[Akiyama & Nakamura 2005]

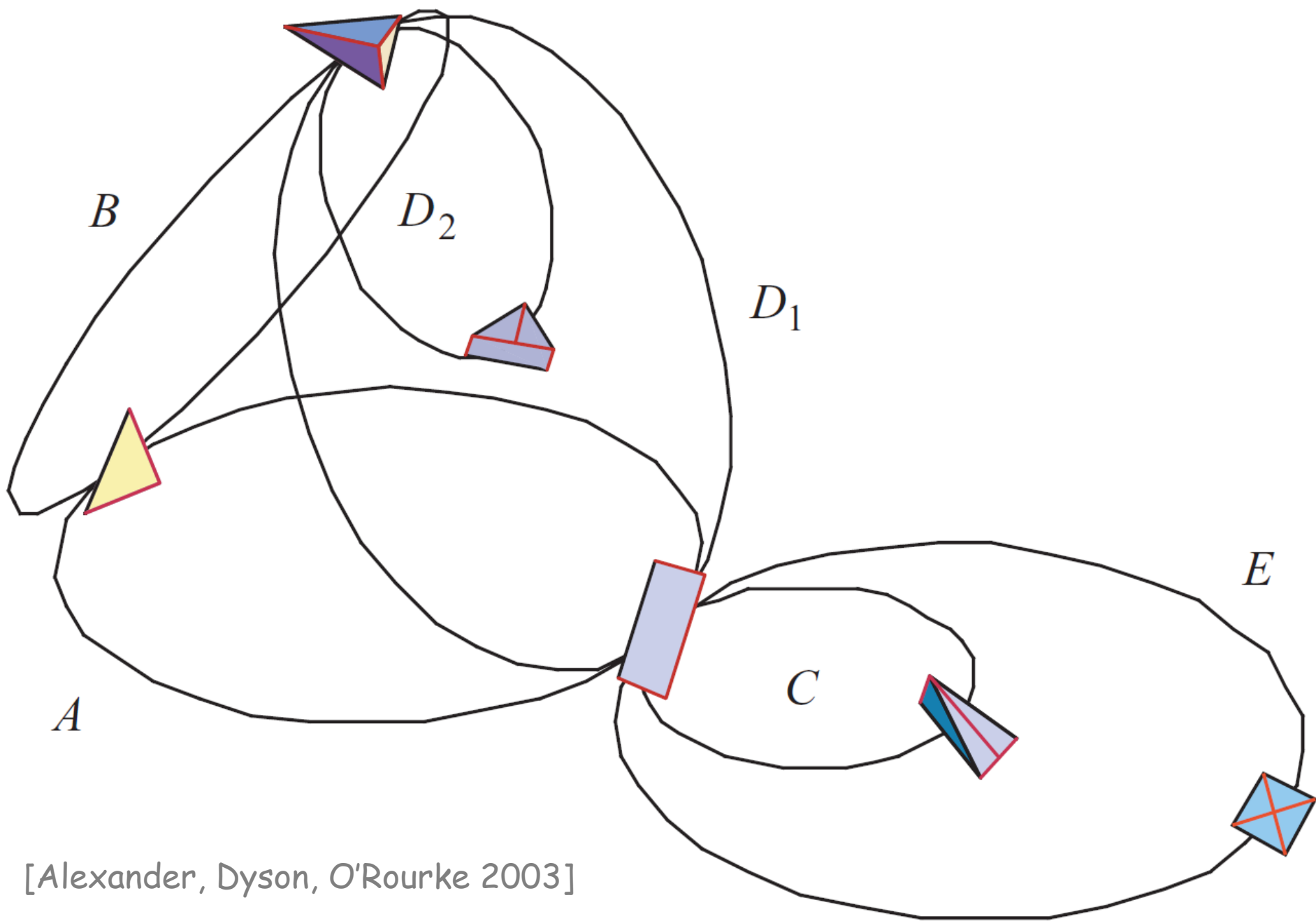

[Alexander, Dyson, O'Rourke 2003]

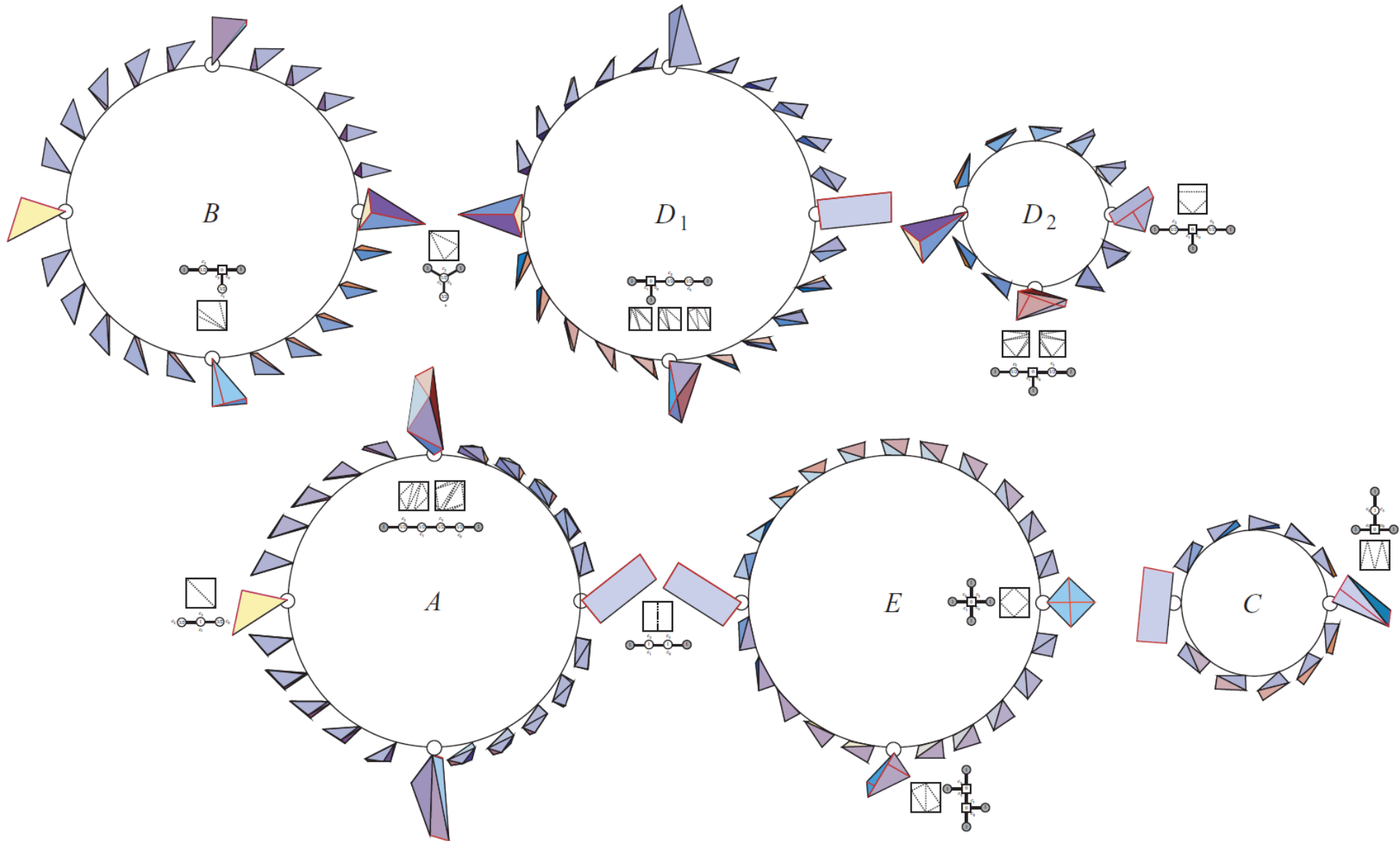

[Alexander, Dyson, O'Rourke 2003]



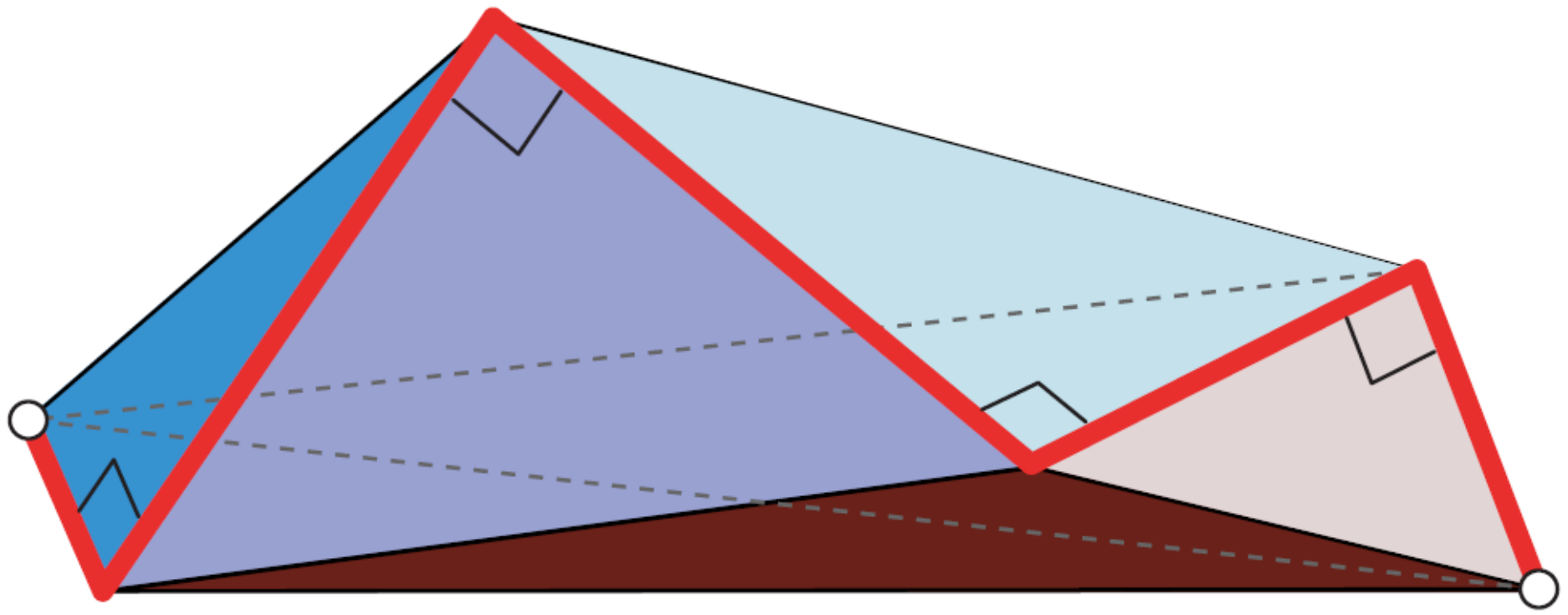

[Alexander, Dyson, O'Rourke 2003]