

regular octahedron & tetramonohedron

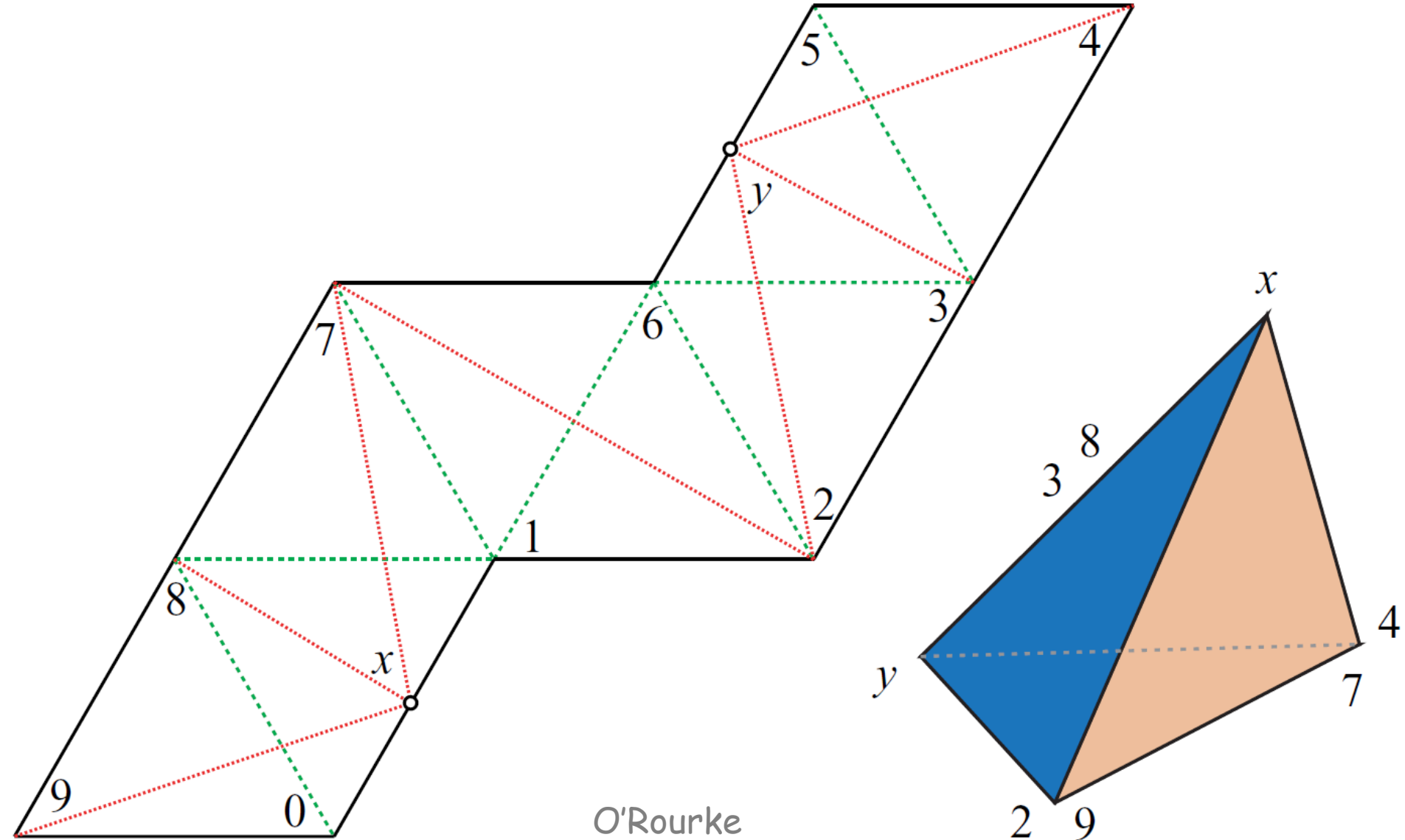

regular octahedron & tetramonohedron

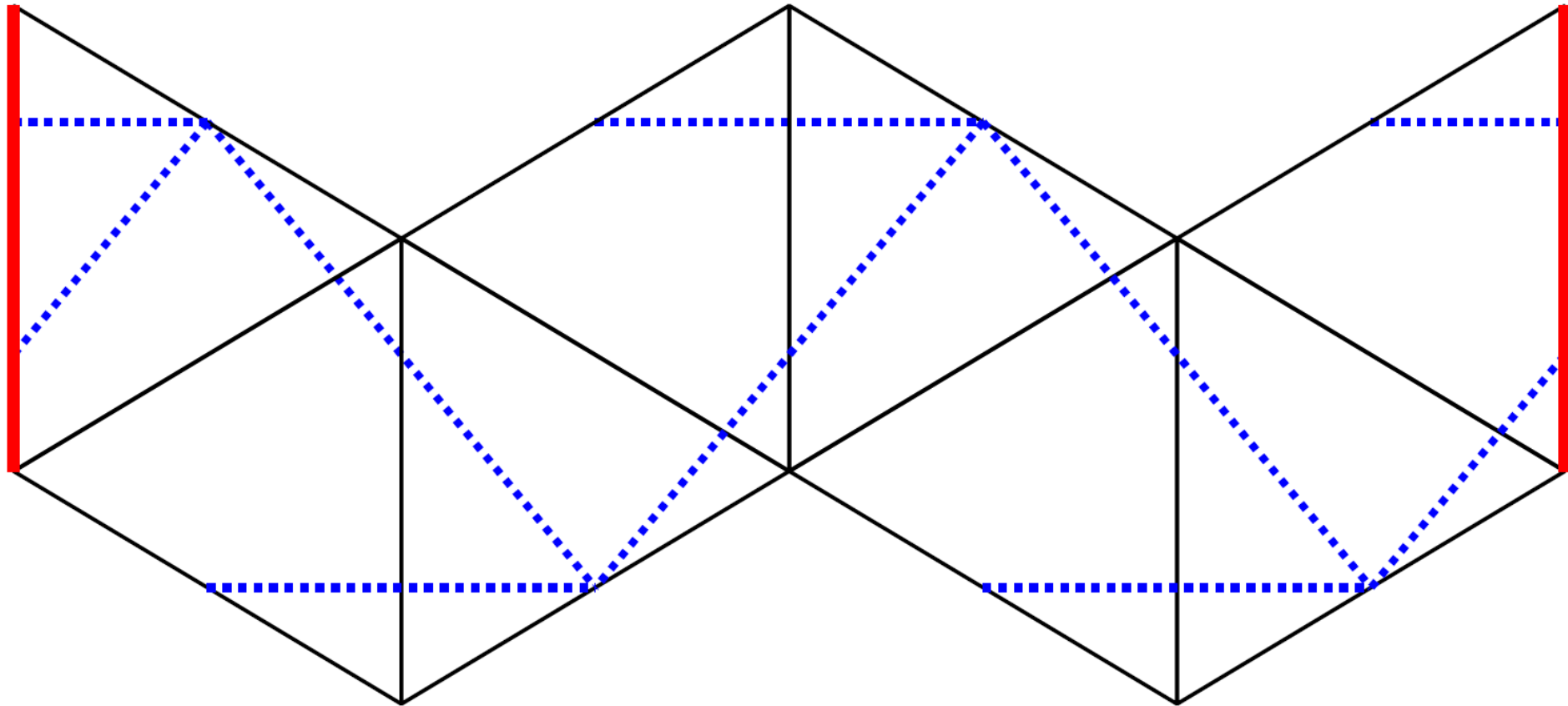



cube &
tetramonohedron

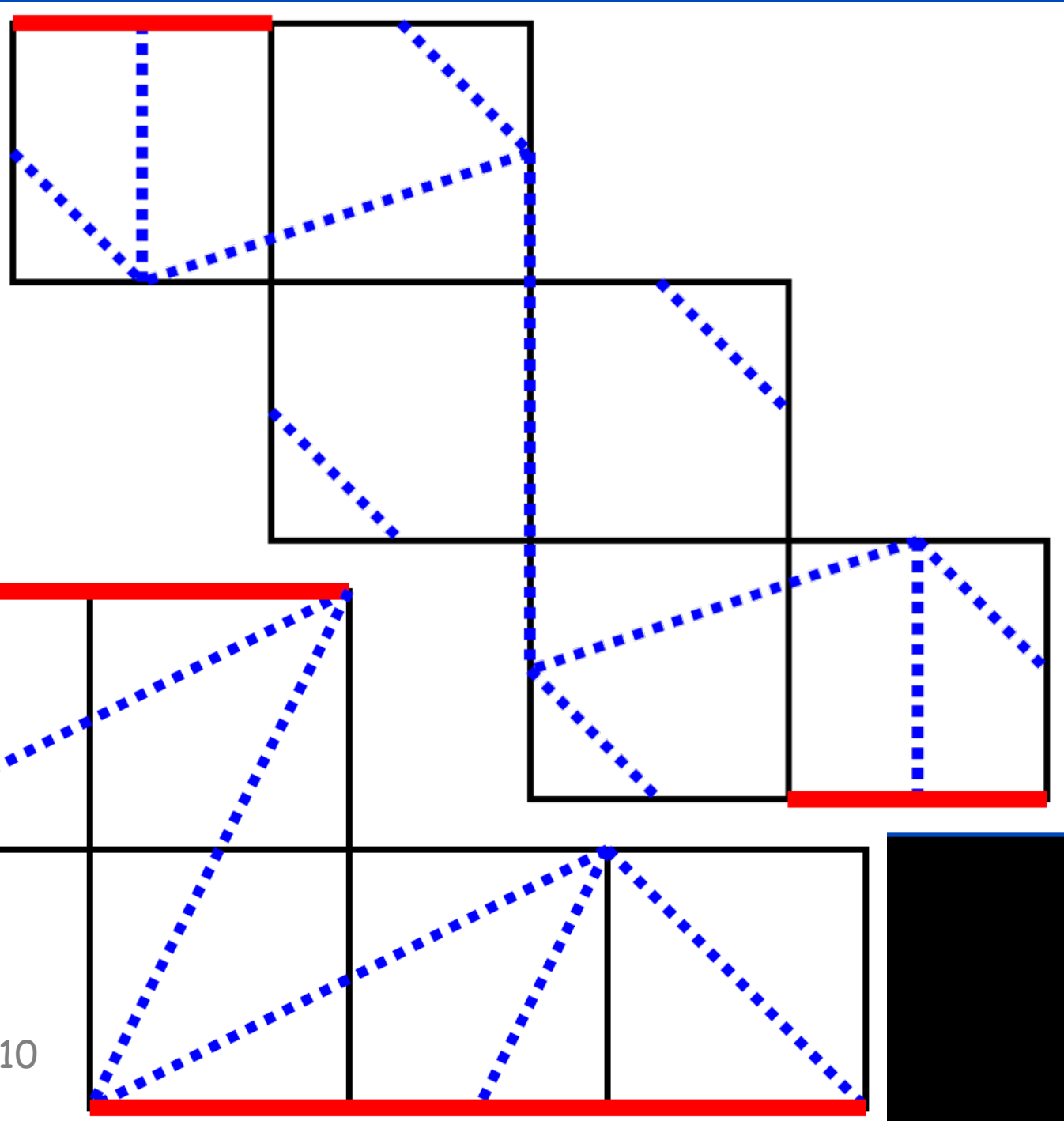

Horiyama & Uehara 2010

regular icosahedron & 1 : 1.145 : 1.25 tetramonohedron

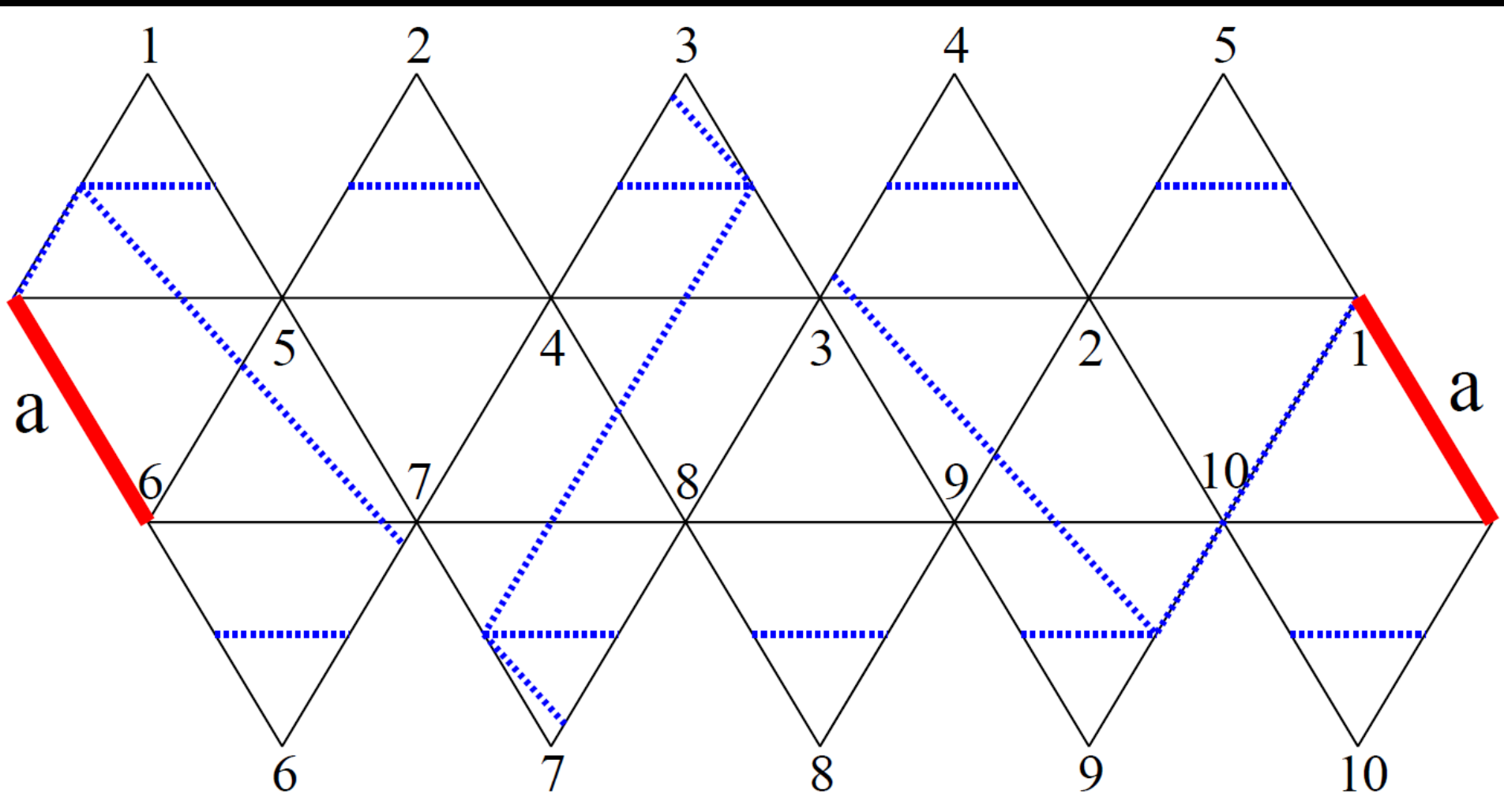

unfoldings of $\sqrt{2} \times \sqrt{2} \times 3\sqrt{2}$ box

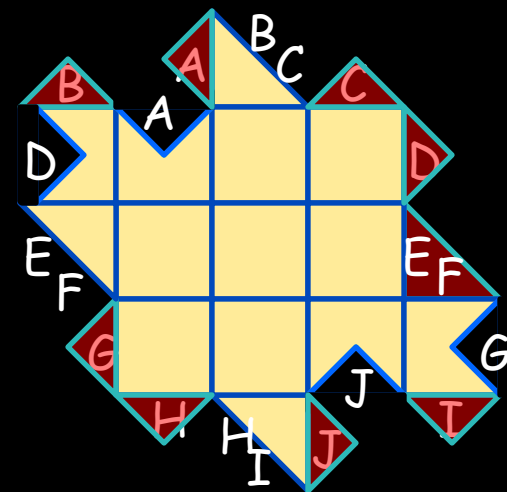
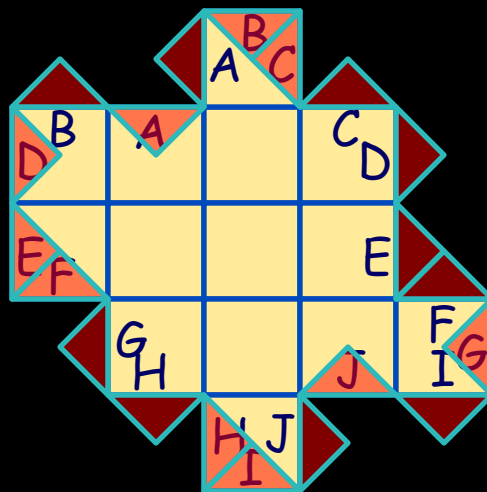
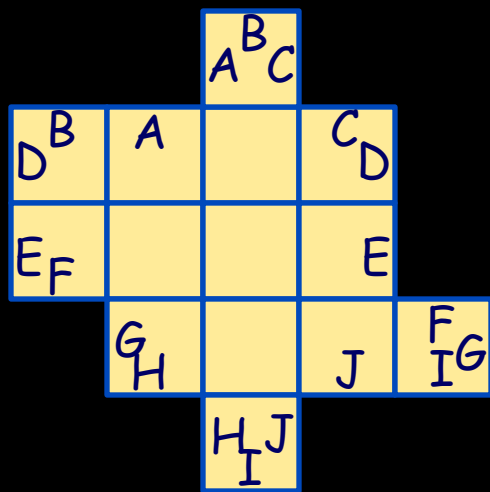

unfolding of
 $1 \times 2 \times 4$ box

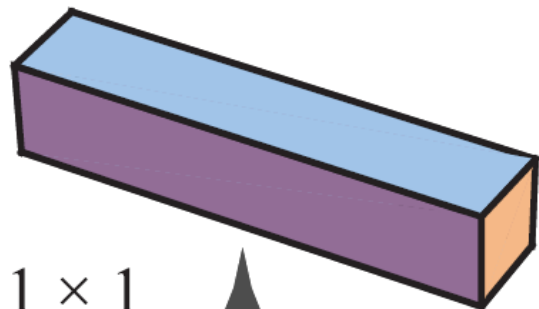

$$5 \times 1 \times 1$$

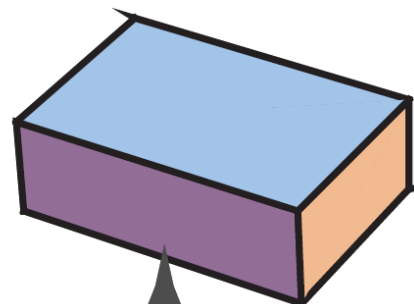
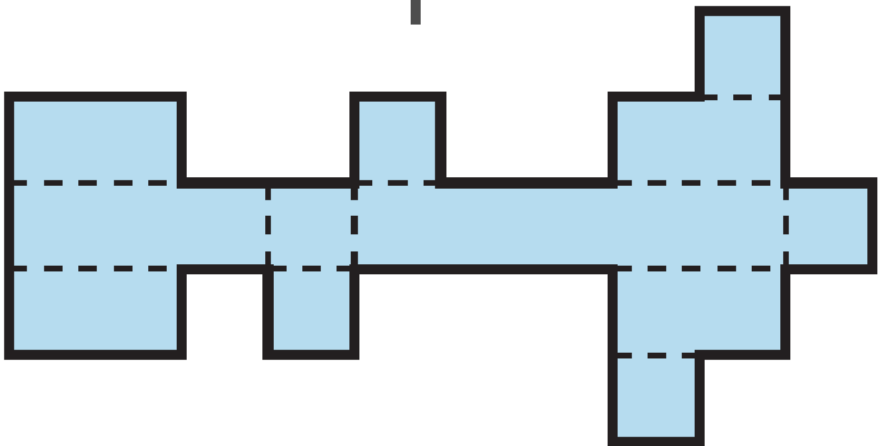

$$3 \times 2 \times 1$$

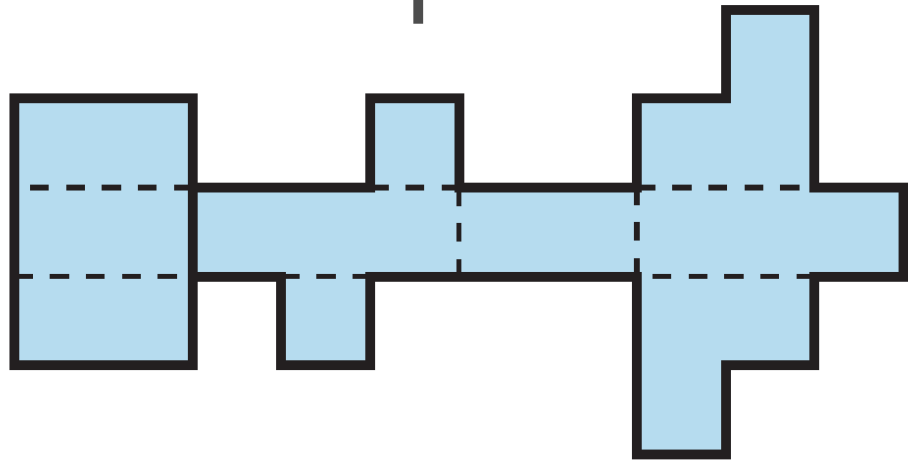

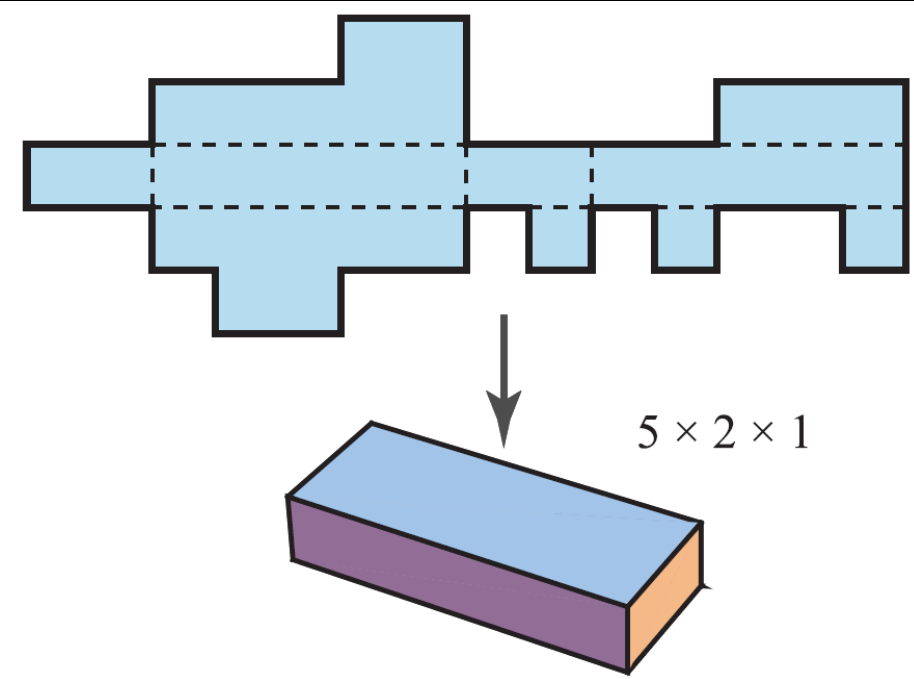
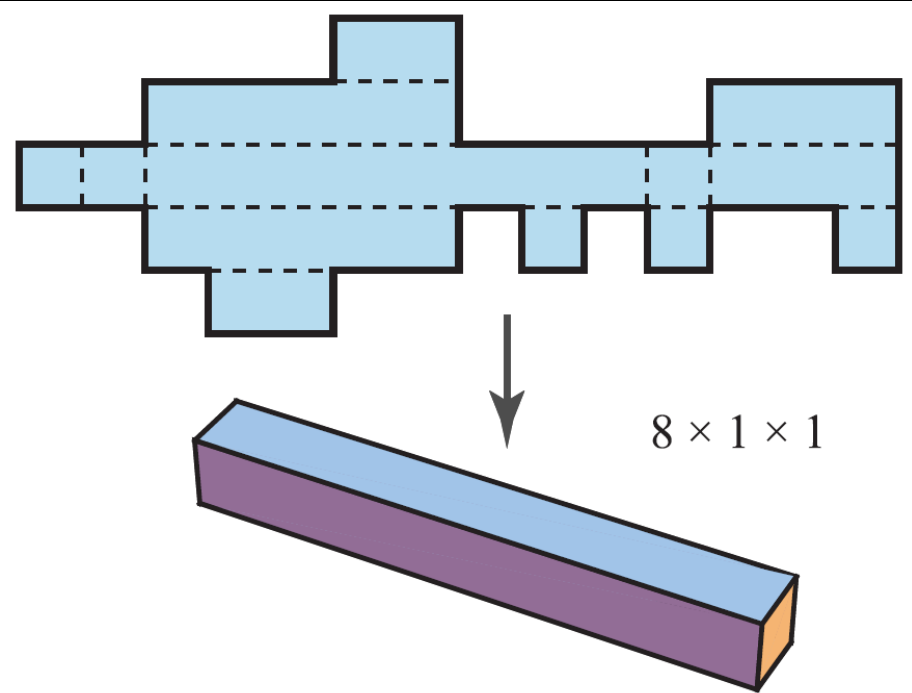

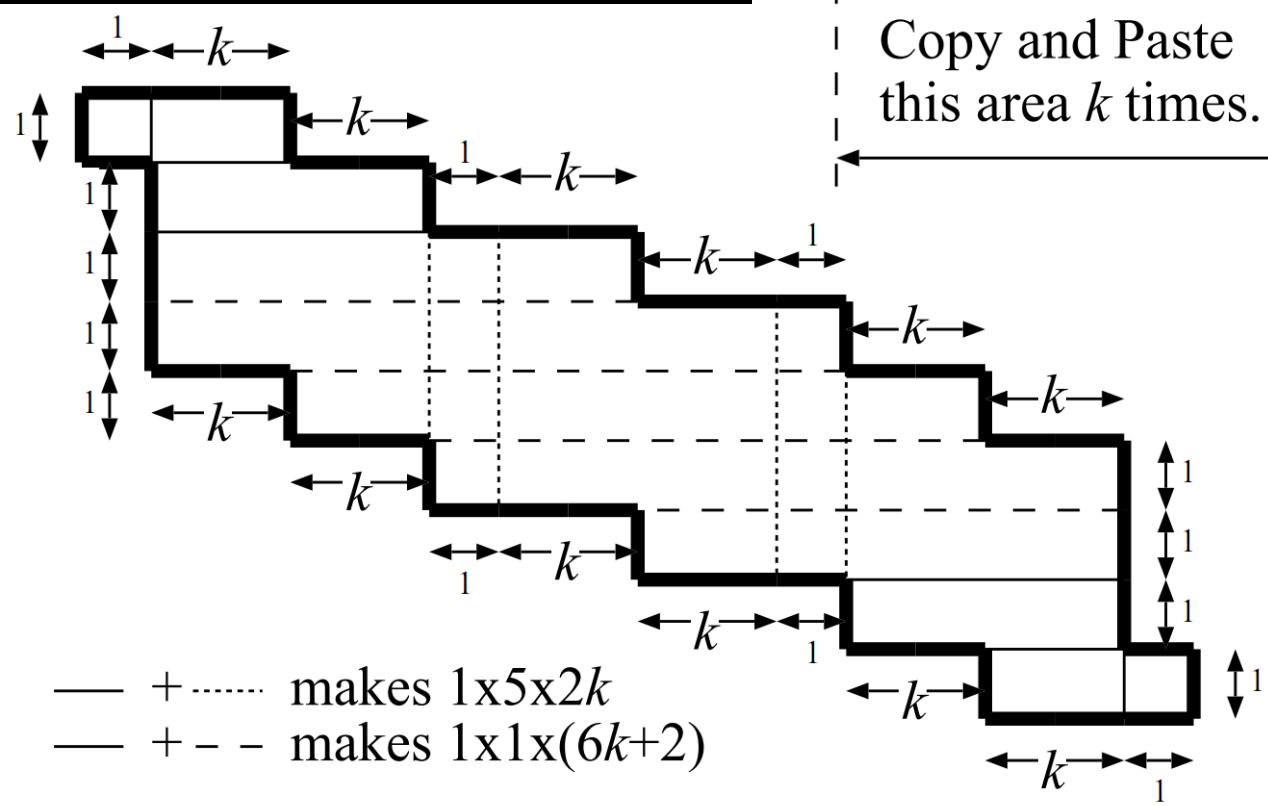
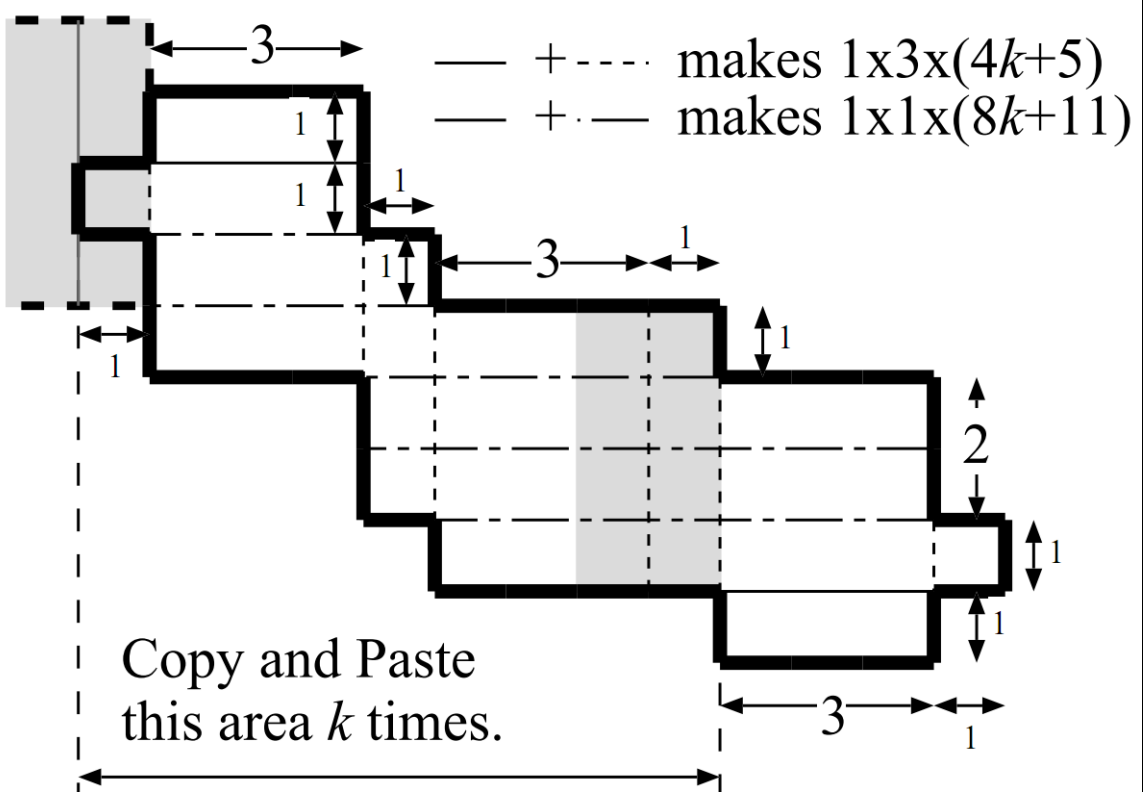

[Uehara 2008]

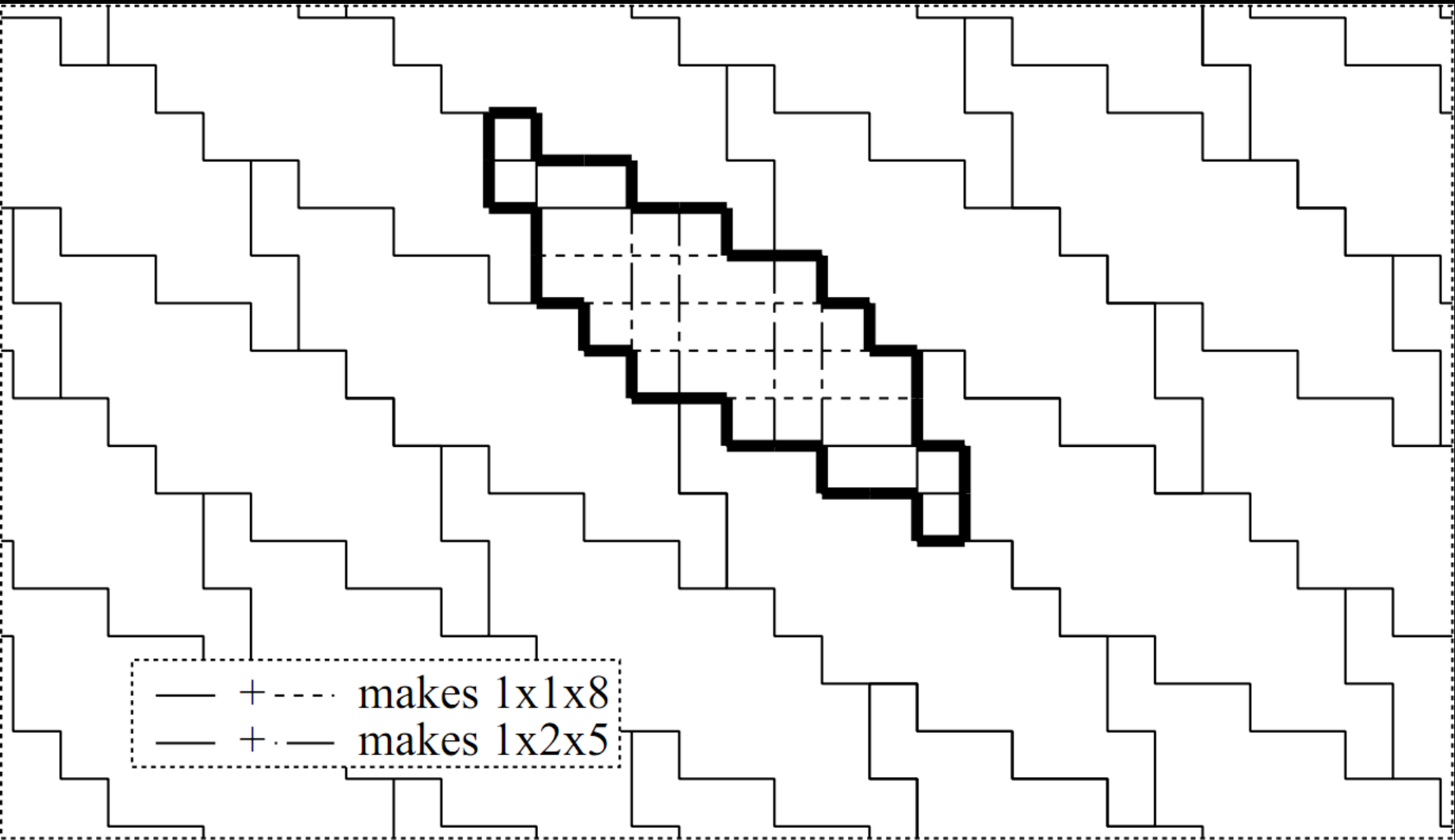



common unfolding of 23 out of 24 pentacubes

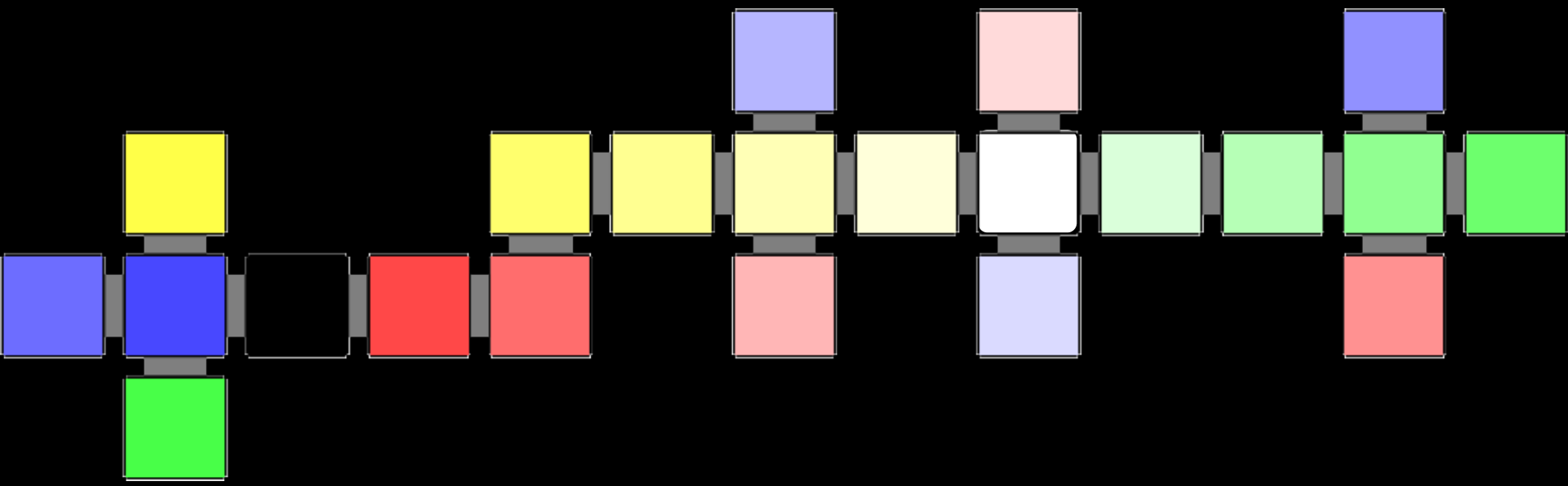

[Aloupis, Benbernou, Bose, Collette, Demaine, Demaine, Douieb, Dujmović, Iacono, Langerman, Morin 2010]

unique common unfolding of nonplanar pentacubes (& 22 total pentacubes)

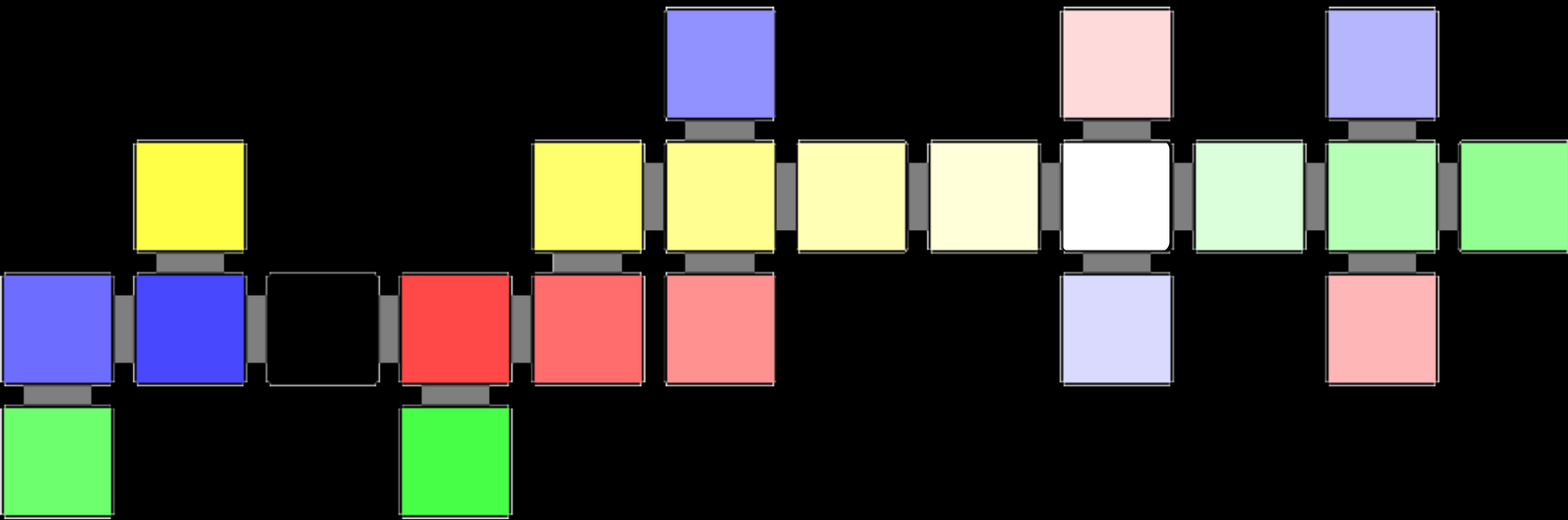

[Aloupis, Benbernou, Bose, Collette, Demaine, Demaine, Douieb, Dujmović, Iacono, Langerman, Morin 2010]

common unfolding of planar pentacubes (& no nonplanar pentacubes)

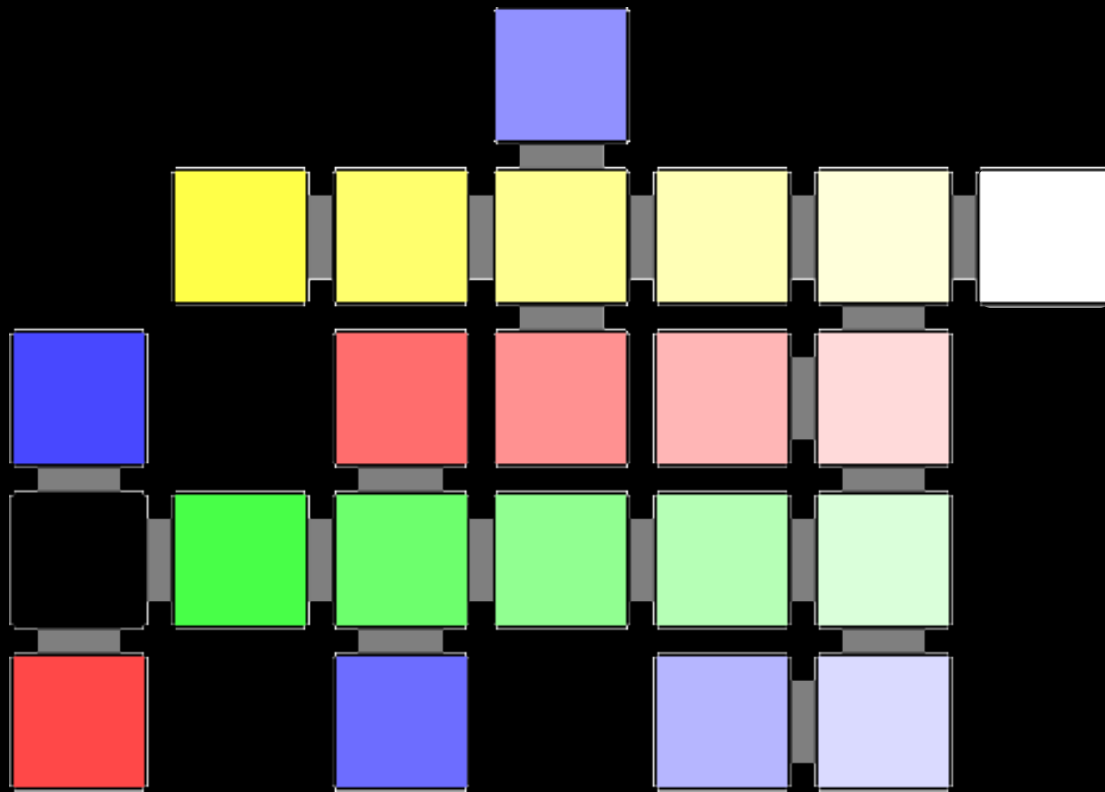

[Aloupis, Benbernou, Bose, Collette, Demaine, Demaine, Douieb, Dujmović, Iacono, Langerman, Morin 2010]

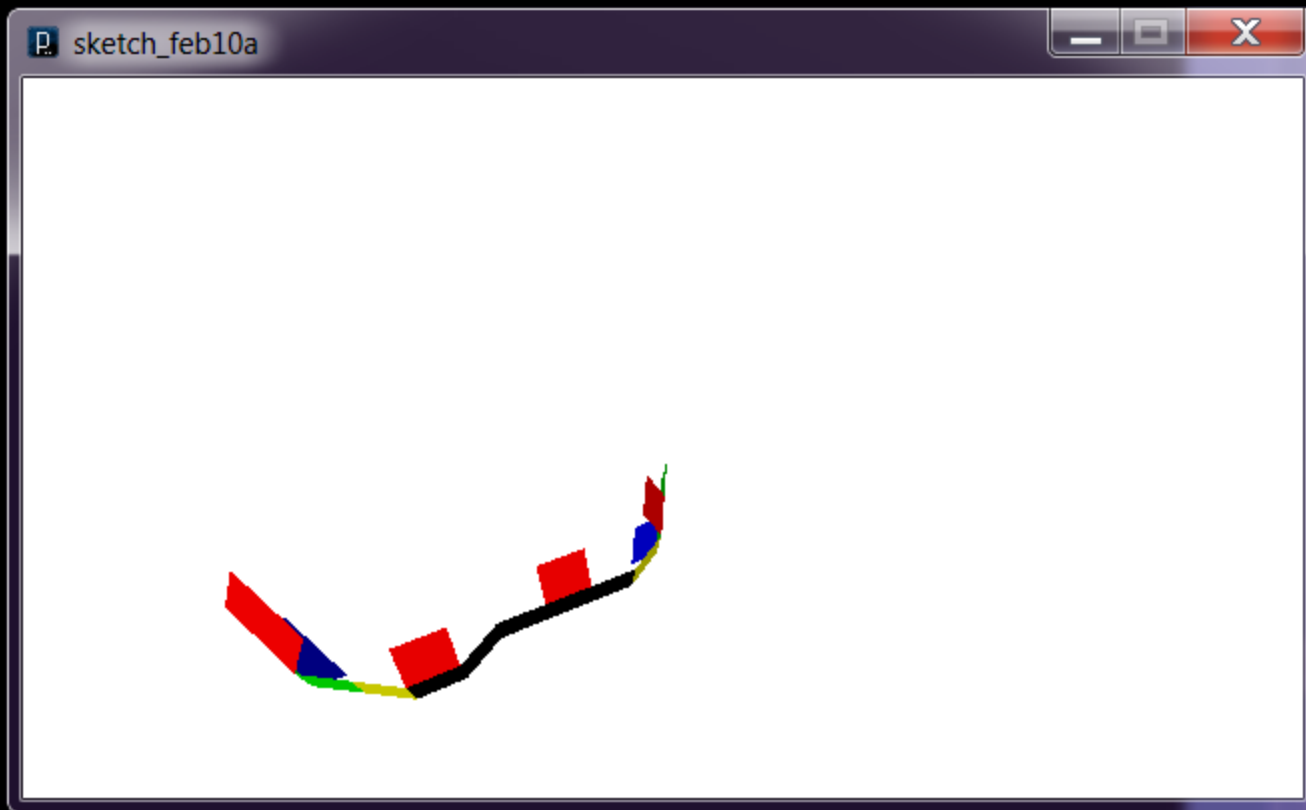

[Aloupis, Benbernou, Bose, Collette, Demaine, Demaine, Douieb, Dujmović, Iacono, Langerman, Morin 2010]

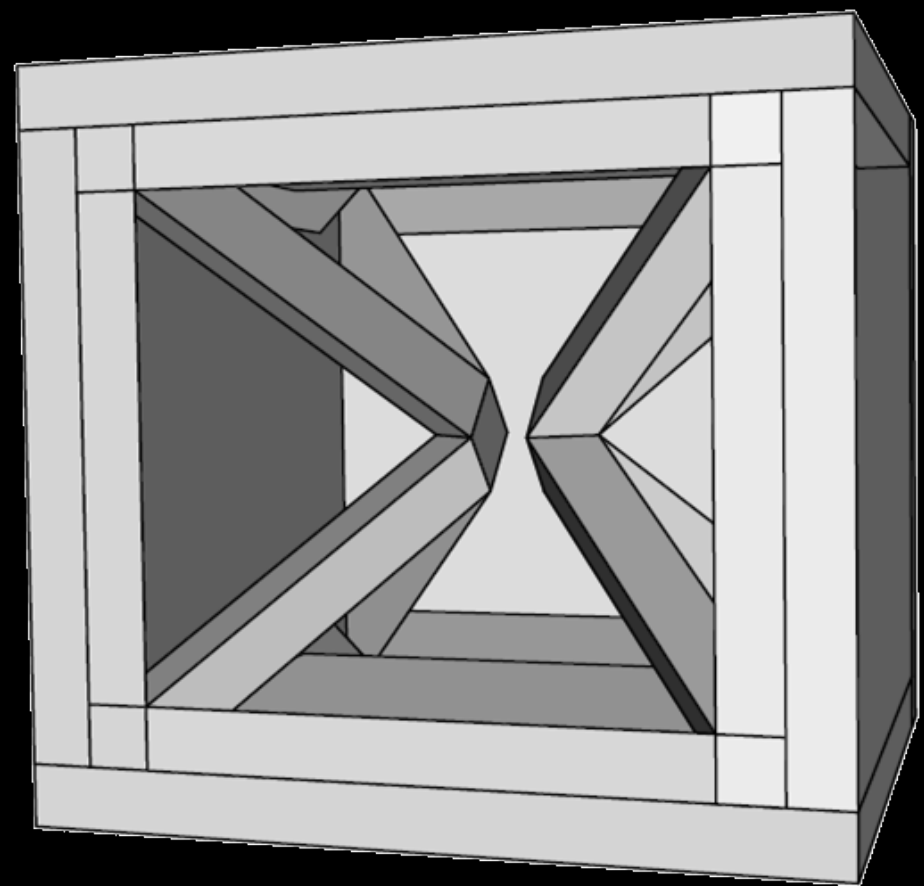
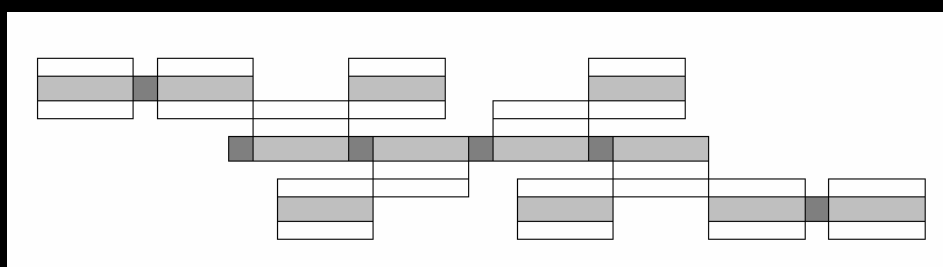
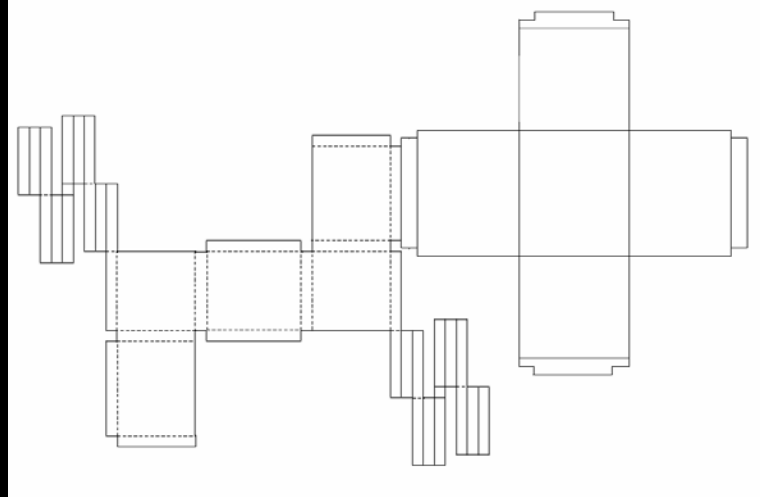
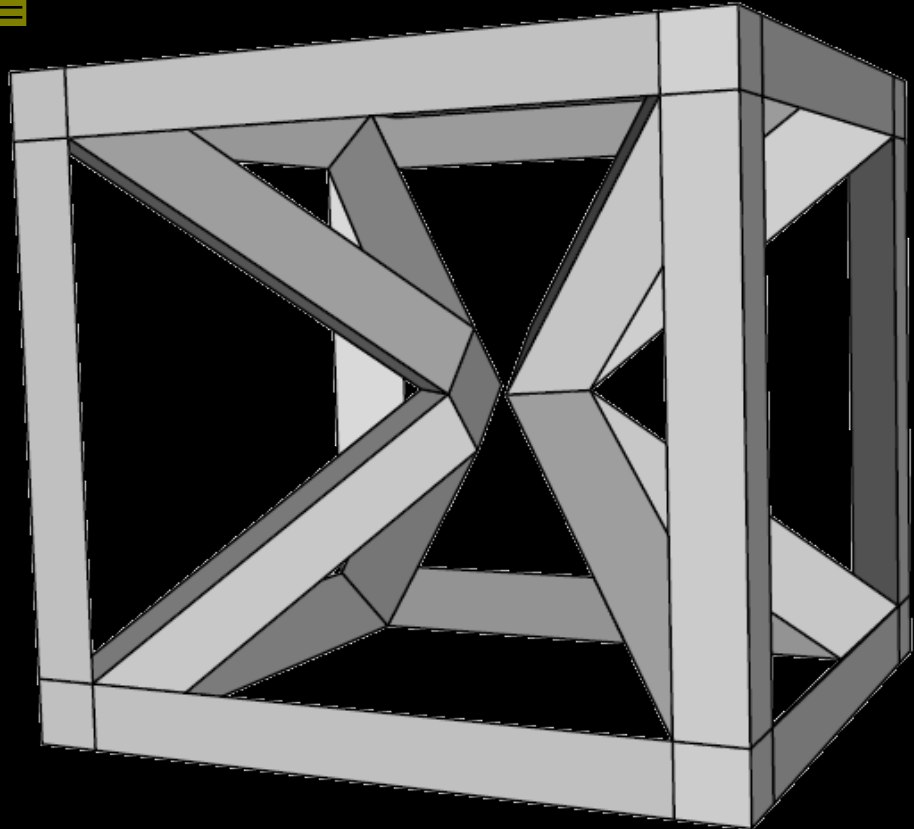



D-forms

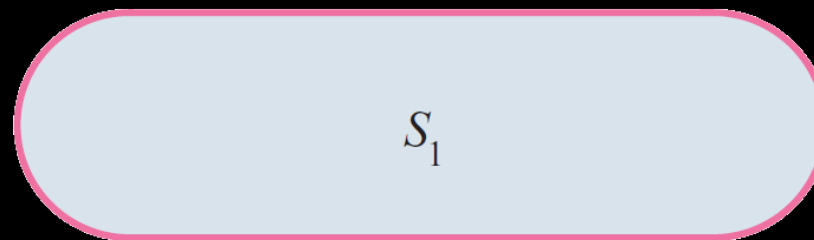
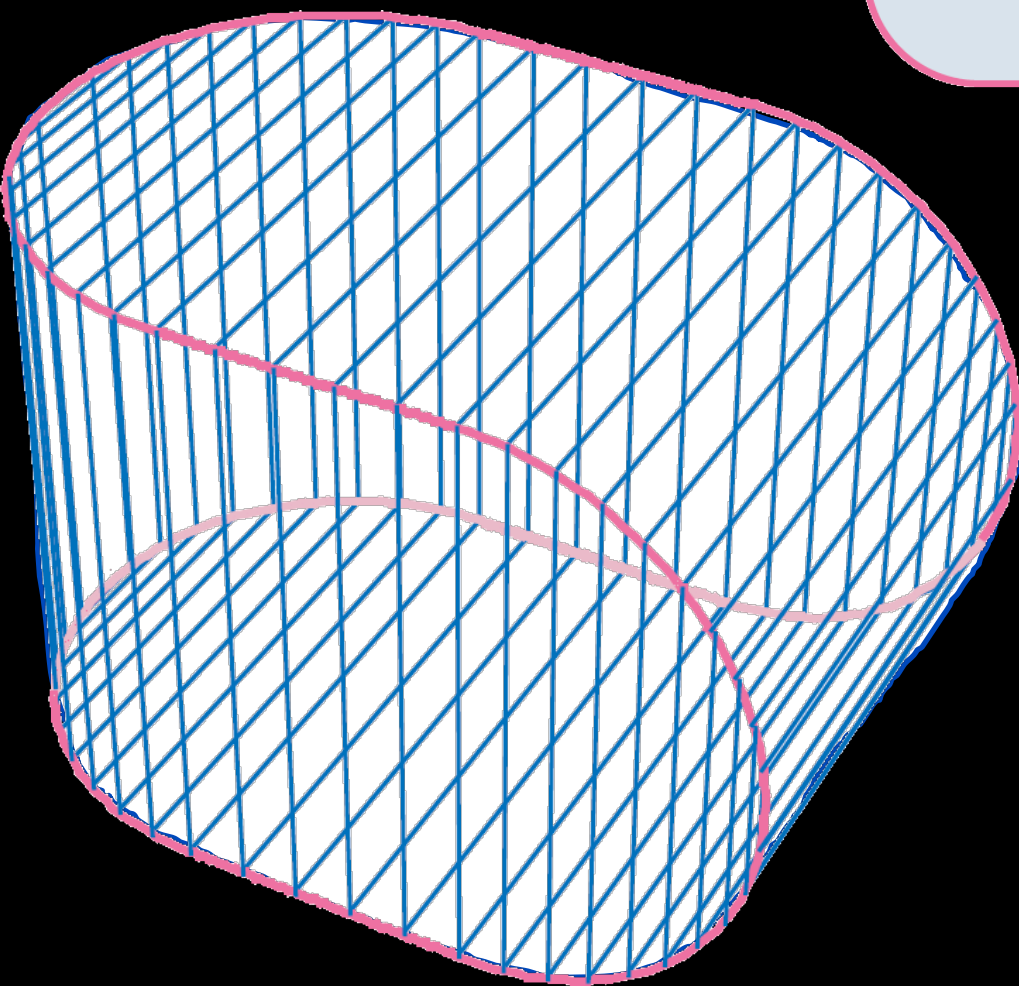

S_1

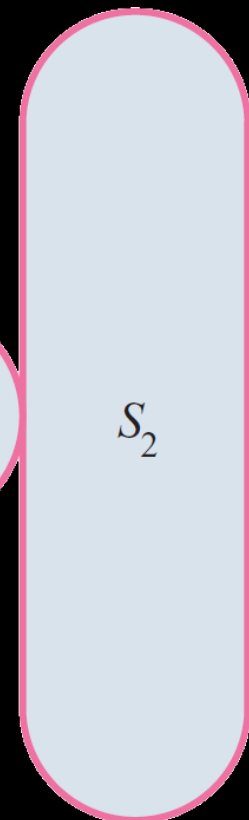

S_2

Tony Wills

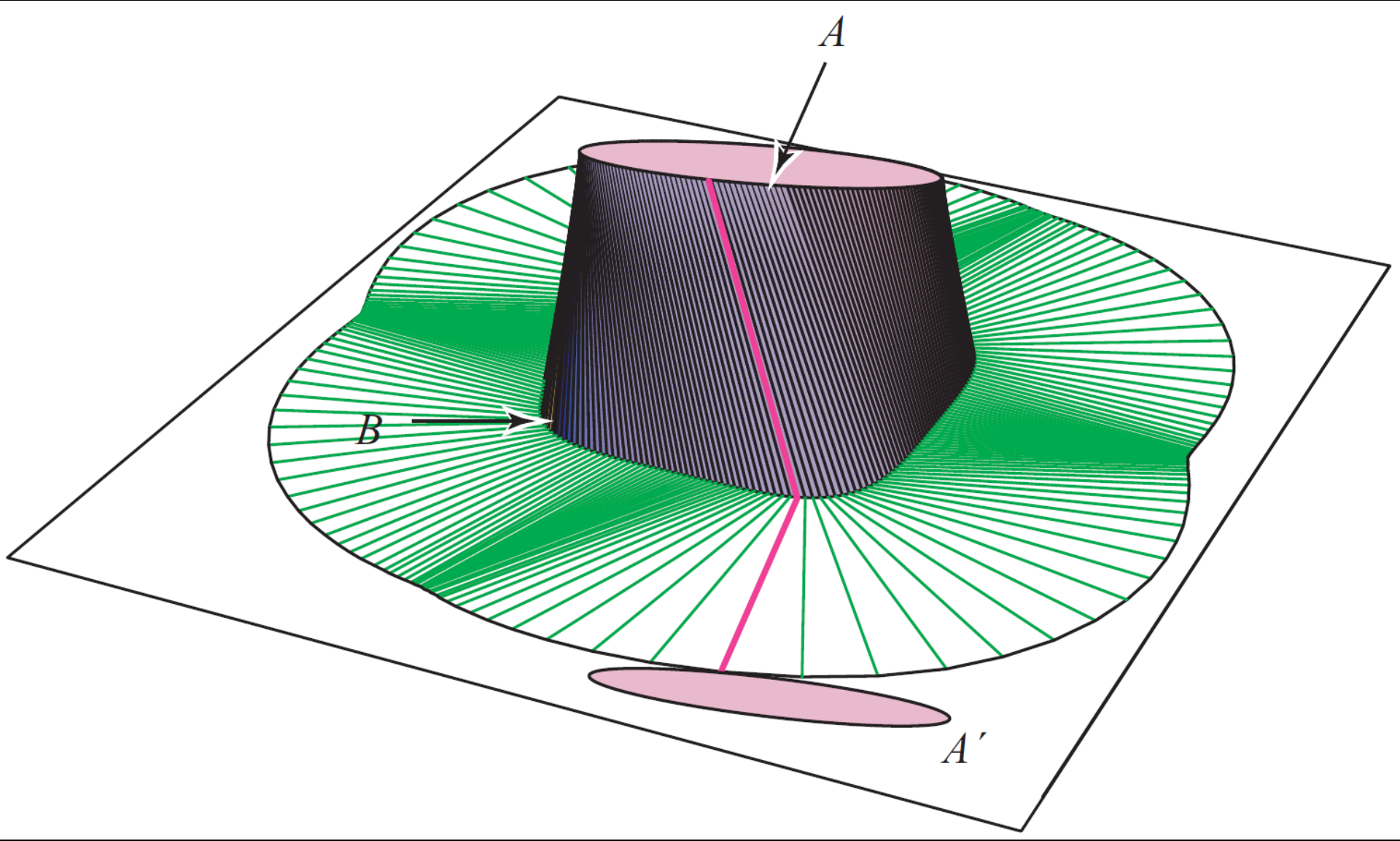

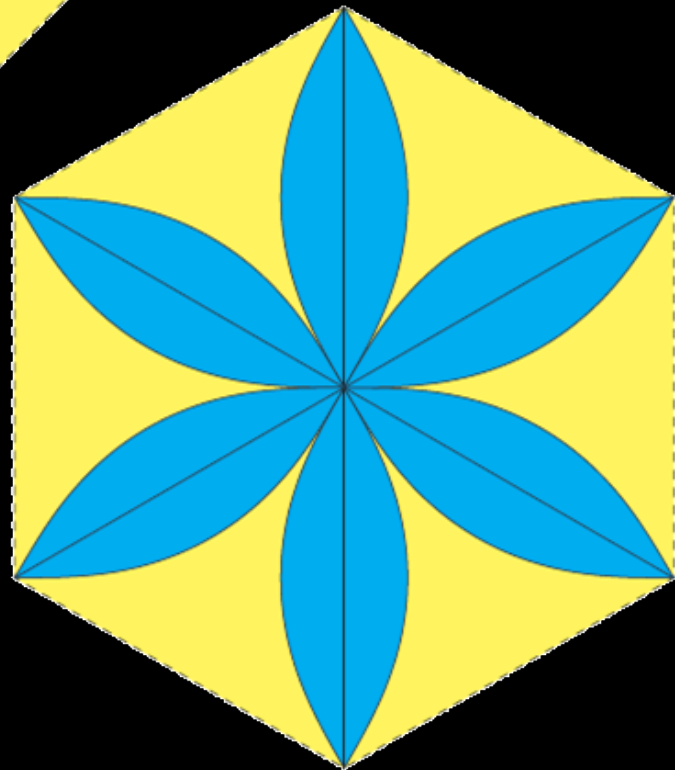
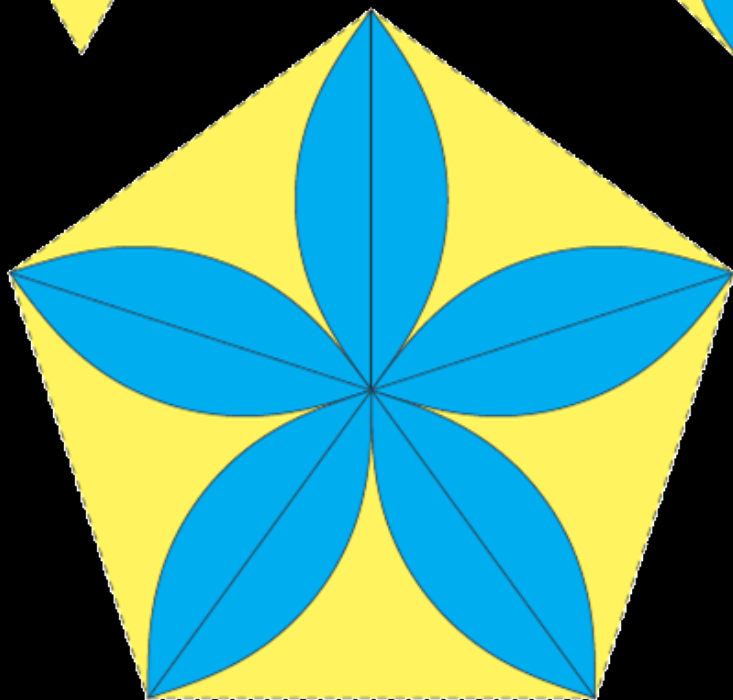
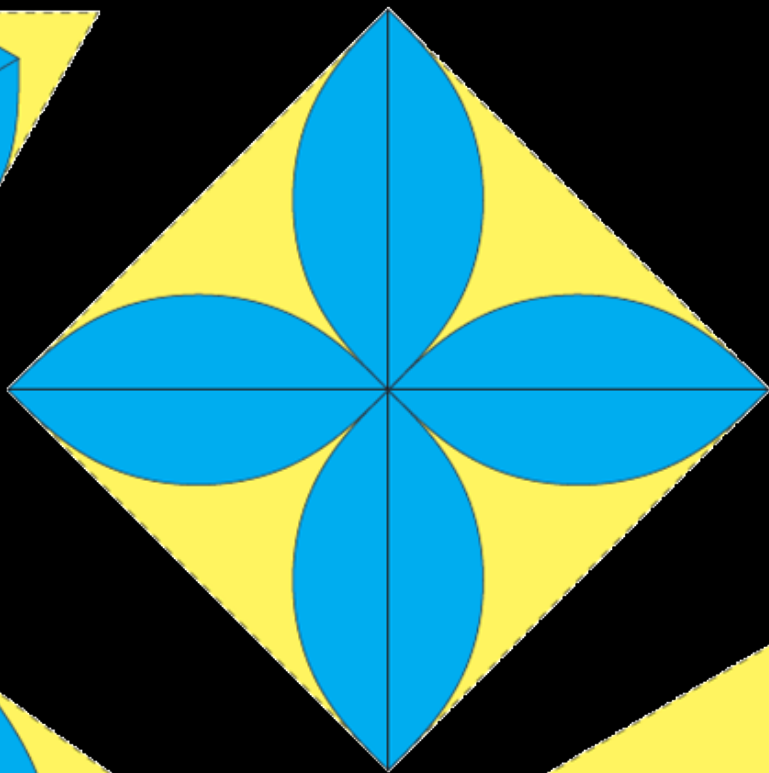
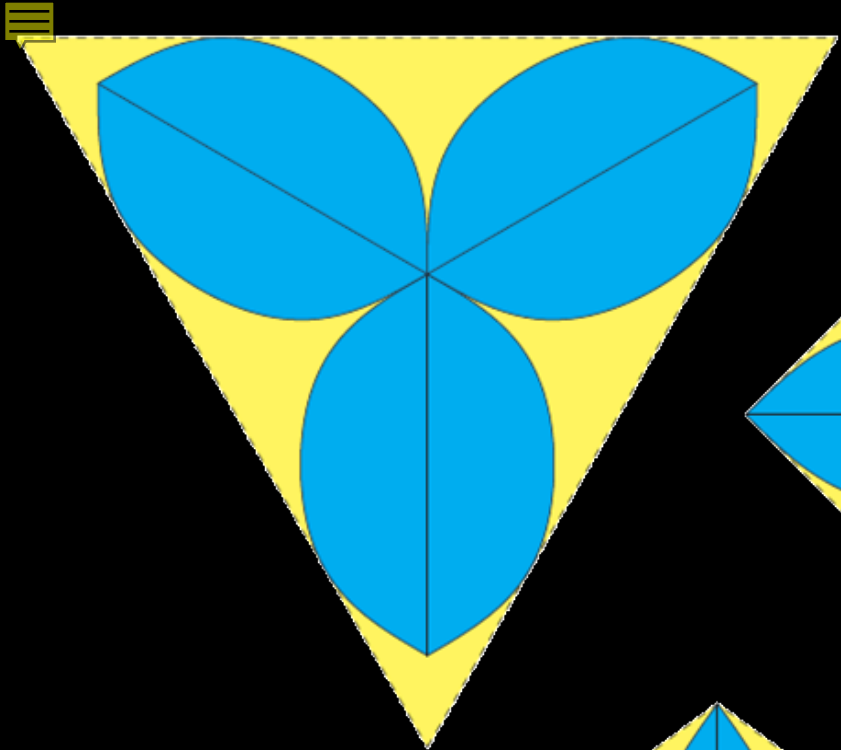

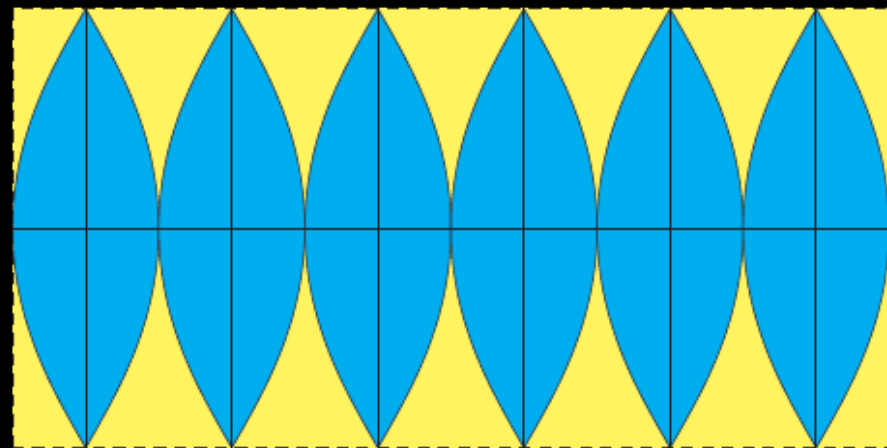
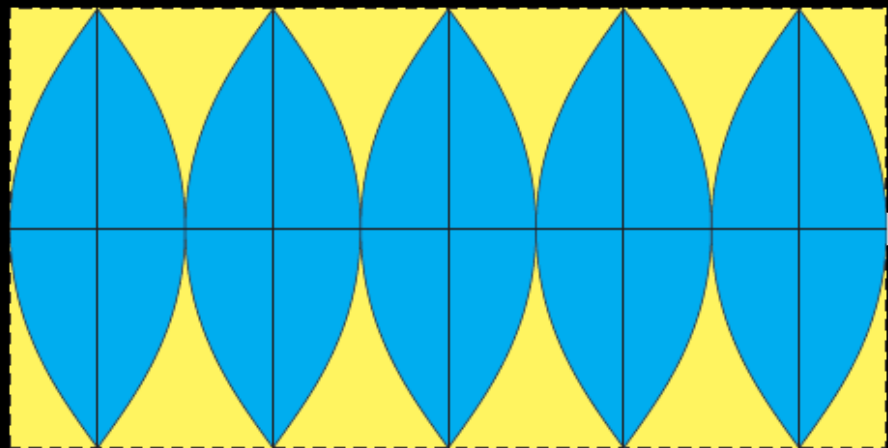
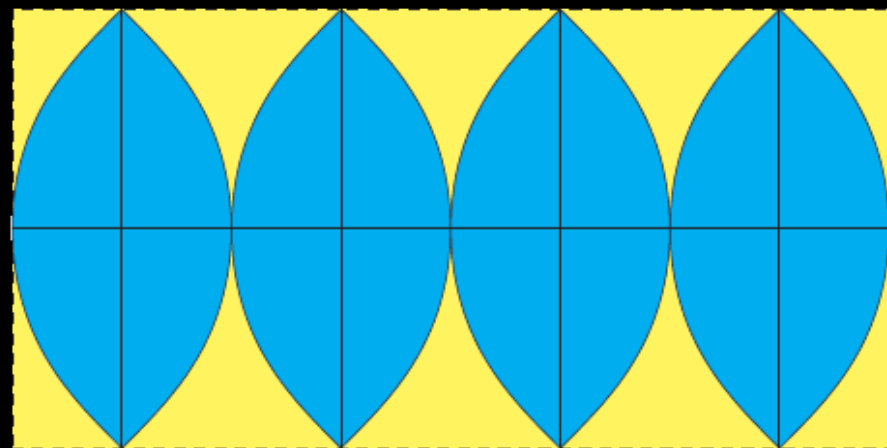
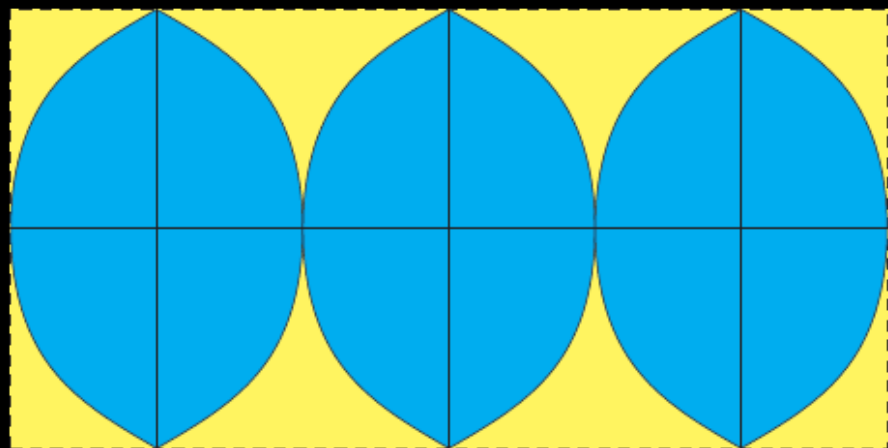

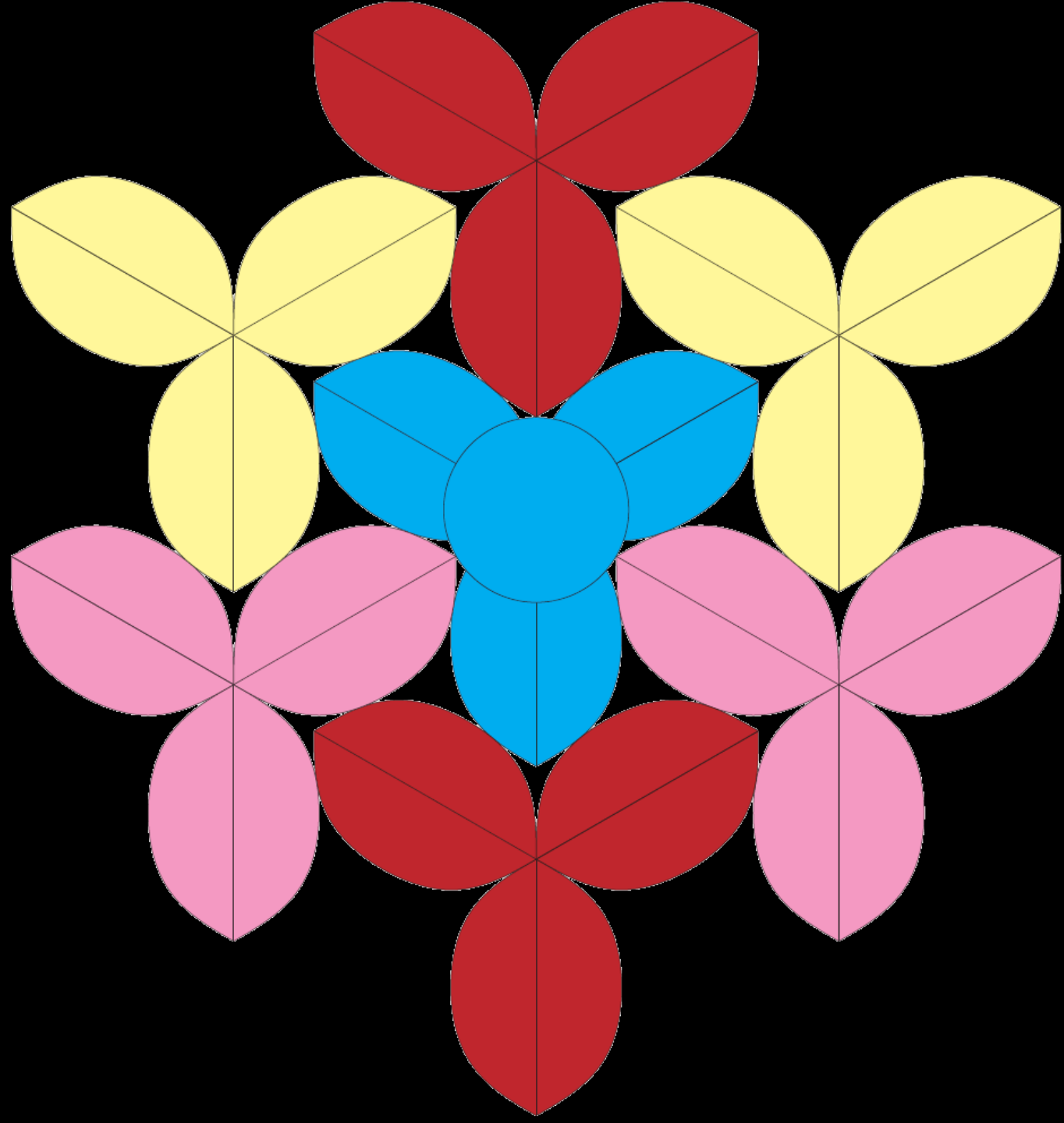

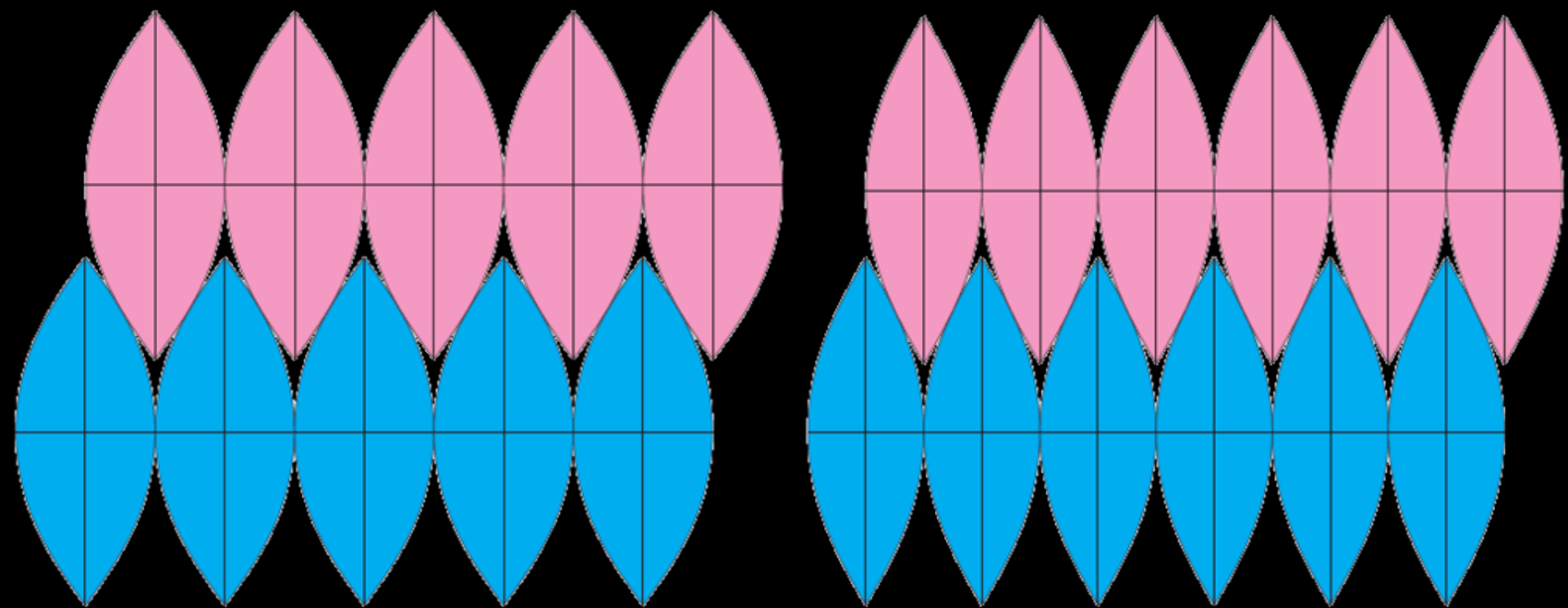
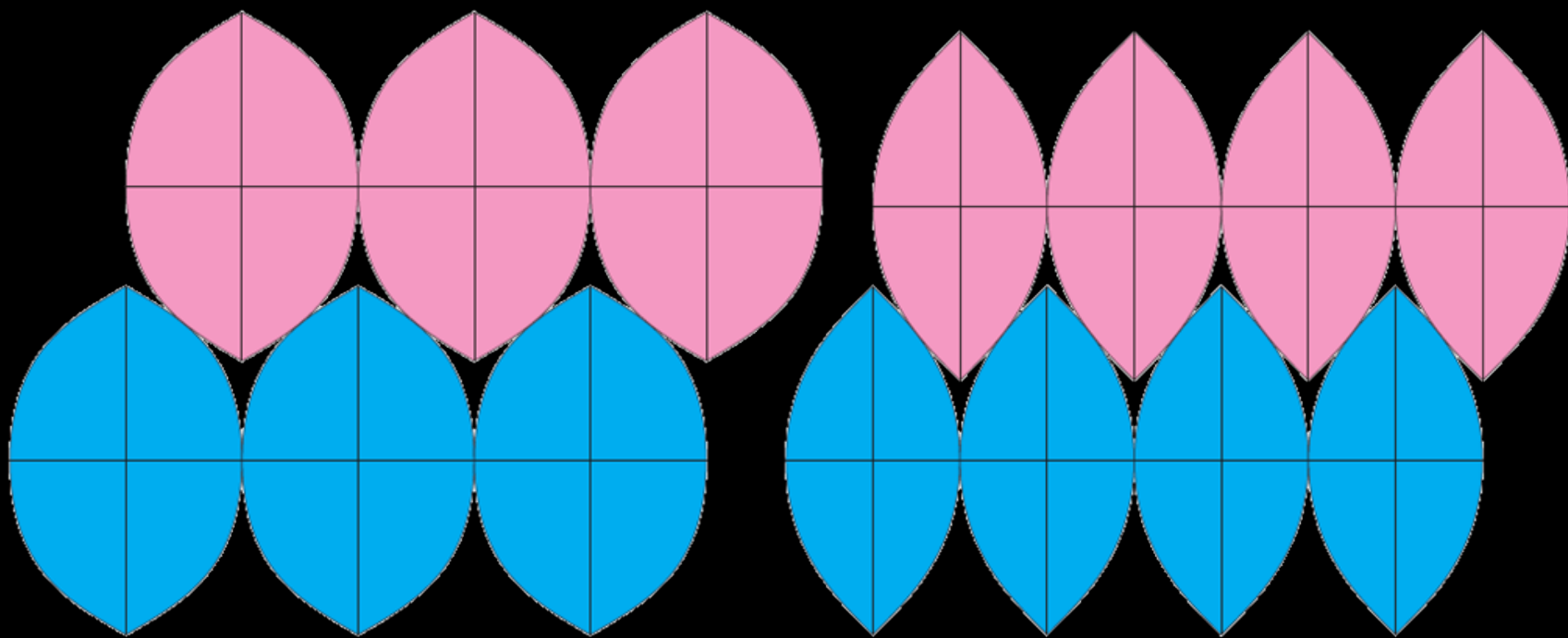



area

