

IS471F

OPIC Light Detector with Built-in Signal Processing Circuit for Light Modulation System

■ Features

1. Impervious to external disturbing lights due to light modulation system
2. Built-in pulse driver circuit and sync. detector circuit on the emitter side
3. A wide range of operating supply voltage (V_{CC} : 4.5 to 16V)

■ Applications

1. Optoelectronic switches
2. Copiers, printers
3. Facsimiles

■ Outline Dimensions

(Unit : mm)

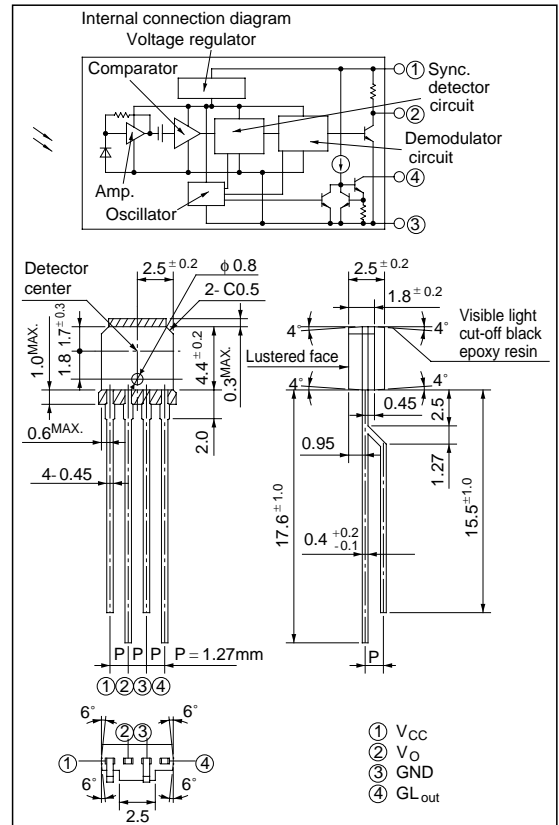

*"OPIC" (Optical IC) is a trademark of the SHARP Corporation.
An OPIC consists of a light-detecting element and signal-processing circuit integrated onto a single chip.

■ Absolute Maximum Ratings

(Ta= 25°C)

Parameter	Symbol	Rating	Unit	
Supply voltage	V_{CC}	-0.5 to 16	V	
Output	Output voltage	V_O	16	V
	Output current	I_O	50	mA
*1 GL output	Output voltage	V_{GL}	16	V
Power dissipation	P	250	mW	
Operating temperature	T_{opr}	-25 to +60	°C	
Storage temperature	T_{stg}	-40 to +100	°C	
*2 Soldering temperature	T_{sol}	260	°C	

*1 Applies to GL_{out} terminal

*2 For 5 seconds at the position shown in the right figure

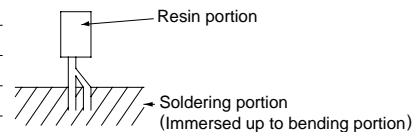

Electro-optical Characteristics

($V_{CC}= 5V, T_a= 25^{\circ}C$)

Parameter		Symbol	Conditions	MIN.	TYP.	MAX.	Unit
Operating supply voltage		V_{CC}	-	4.5	-	16	V
Supply current		I_{CC}	V_O, GL_{out} terminals shall be opened.	-	3.5	7.0	mA
Output	Low level output voltage	V_{OL}	$I_{OL}= 16mA, E_{VP}= 500lx, E_{VD}= 0^{*3}$	-	0.15	0.35	V
	High level output voltage	V_{OH}	$E_{VD}= E_{VP}= 0^{*3}$	4.97	-	-	V
	Output short circuit current	I_{OS}	$E_{VP}= E_{VD}= 0^{*3}$	0.25	0.5	1.0	mA
GL output	Low level output current	I_{GL}	$V_{GL}= 1.2V$	40	55	70	mA
	^{*4} Pulse cycle	t_p	-	70	130	220	μs
	^{*4} Pulse width	t_w	-	4.4	8	13.7	μs
^{*5} "Low→High" threshold irradiance		E_{ePLH}	$E_{eD}= 0^{*3}$ Light emitting diode ($\lambda_p= 940nm$) ^{*6}	-	0.4	2.66	$\mu W/mm^2$
^{*5} "High→Low" threshold irradiance		E_{ePHL}		-	0.7	2.8	$\mu W/mm^2$
Hysteresis		E_{ePLH}/E_{ePHL}		0.45	0.65	0.95	-
Response time	"High→Low" propagation delay time	t_{PHL}	^{*6}	-	400	670	μs
	"Low→High" propagation delay time	t_{PLH}	^{*6}	-	400	670	μs
^{*7} External disturbing light illuminance		E_{VDX}	$E_{ep}= 7.5 \mu W/mm^2, ^{*3} \lambda_p= 940nm$	2000	7500	-	lx

^{*3} E_{eP} represents illuminance of signal light in sync with the low level timing of output at GL_{out} terminal.

E_{eD} represents illuminance of DC light. For detail, see Fig. 1.

Light source: Infrared light emitting diode ($\lambda_p= 940nm$)

E_{VP} represents illuminance of signal light in sync with the low level timing of output at GL_{out} terminal.

E_{VD} represents illuminance of DC light. Note that the light source is CIE standard light source A.

Fig.1

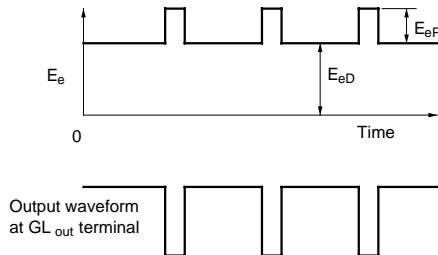

(Note) Fig. 1 shows the output waveform at GL_{out} terminal with **IS471F** connected as shown in Fig. 3.

^{*4} Pulse cycle (t_p), pulse width (t_w) are defined as shown in Fig. 2.

The waveform shown in Fig. 2 is the output voltage waveform at GL_{out} terminal with **IS471F** connected as shown in Fig. 3

Fig.2

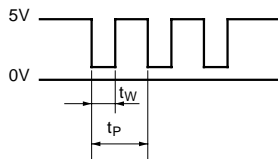
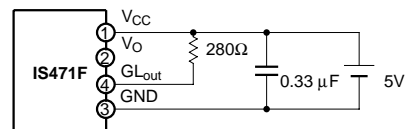

Fig.3



^{*5} Defined as E_{ep} that causes the output to go " Low to High" (or " High to Low").

*6 Test circuit for response time, threshold irradiance is shown in Fig. 4.

Fig. 4

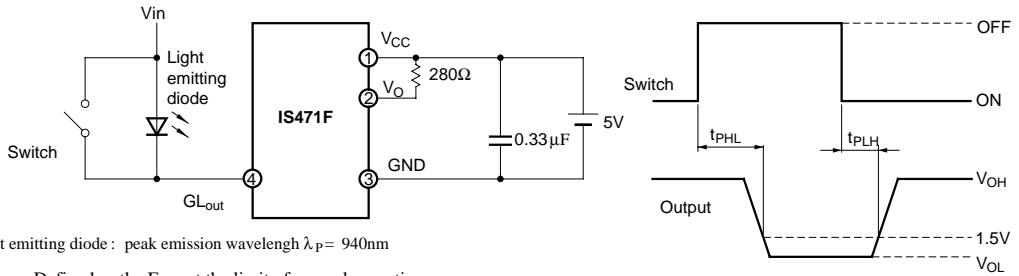

*7 E_{VDX} : Defined as the E_{VD} at the limit of normal operation range.

Fig. 5 Power Dissipation vs. Ambient Temperature

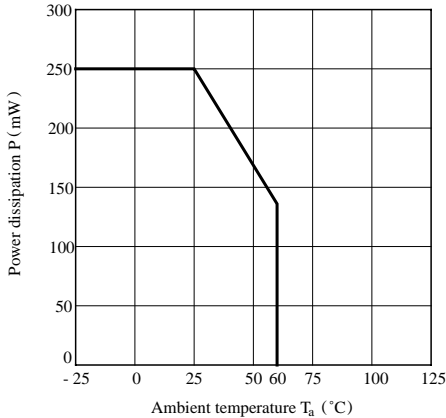

Fig. 6 Low Level Output Voltage vs. Low Level Output Current

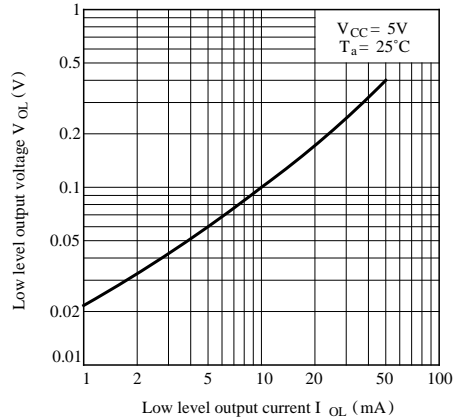

Fig. 7 Low Level Output Voltage vs. Ambient Temperature

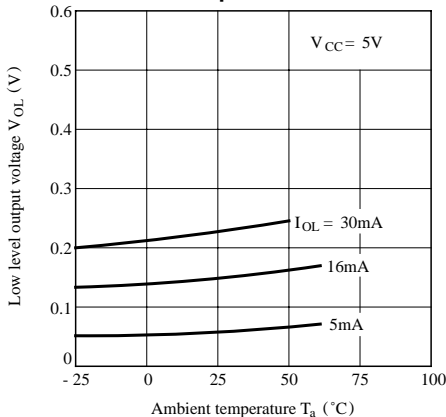

Fig. 8 Supply Current vs. Supply Voltage

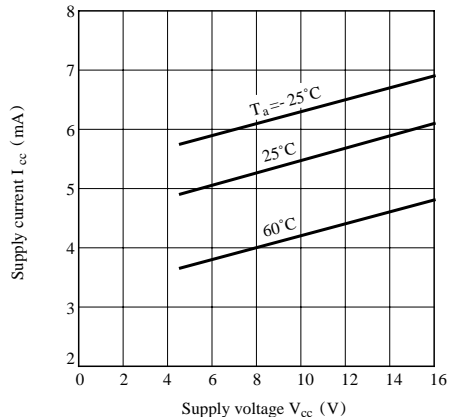

Fig. 9 Low Level Output Current vs. Supply Voltage

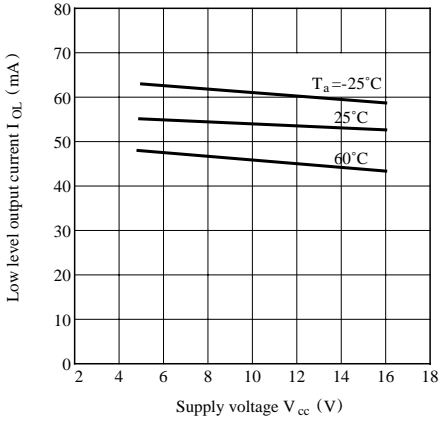

Fig.10 Sensitivity Diagram ($T_a = 25^\circ\text{C}$)

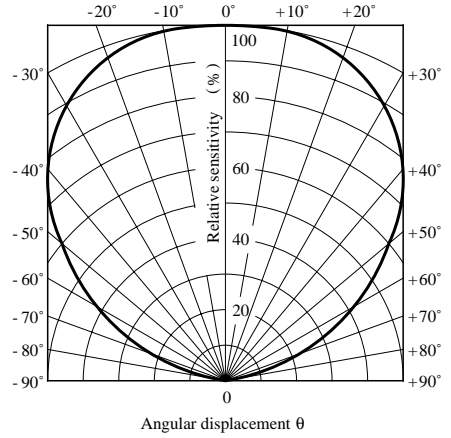
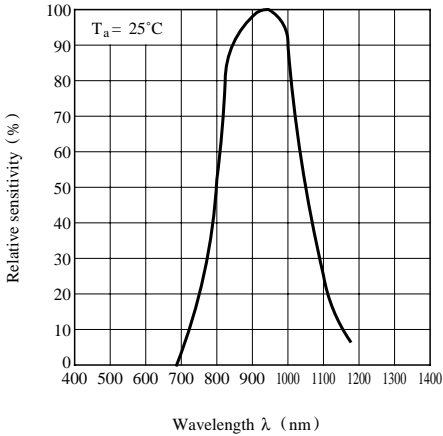
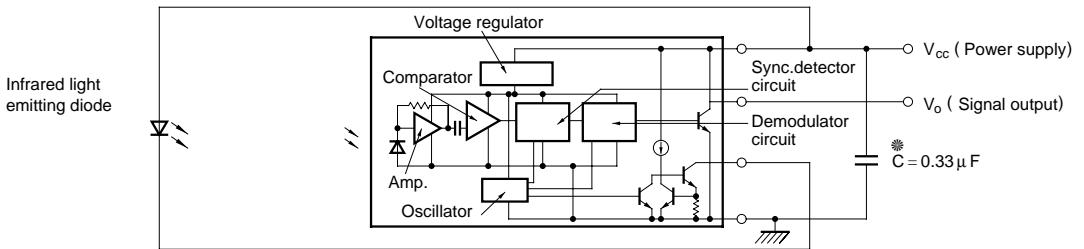

Fig.11 Spectral Sensitivity



Basic Circuit



※ In order to stabilize power supply line, connect a by-pass capacitor of $0.33\mu\text{F}$ or more between V_{cc} and GND near the device.

● Please refer to the chapter “Precautions for Use.”